

DeVorm

Recommended Sales Price List 2023





Products (1/2)

Products (2/2)

Chairs & Stools

Hale Series

	Seat + backrest	Qty	Frame Black/White	Frame Custom colour ¹	Frame Fine texture ²
Hale Stack Chair 	Dark Grey, Light Grey	1	€ 248,00	€ 270,00	€ 276,00
	Colour blends	1	€ 264,00	€ 286,00	€ 292,00

Hale Stack Chair Armrests 	Dark Grey, Light Grey	1	€ 281,00	€ 303,00	€ 309,00
	Colour blends	1	€ 298,00	€ 320,00	€ 326,00

Setup costs custom colour treatment (frame)

- Setup costs for the first colour are € 225,00
- Setup costs for every next colour are € 75,00

Measurements

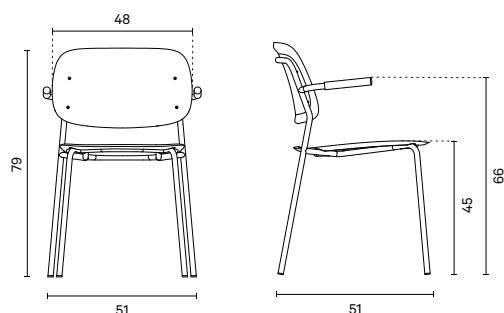

Specifications

Designed by	De Vorm & Ivan Kasner
Frame	Powder-coated steel
Standard frame colours	Black (RAL 9011) / White (RAL 9010) with 70% gloss degree
Seat + backrest	PET Felt
PET Felt blends	Marine, Turquoise, Olive, Dark Green, Green, Yellow, Pink, Dark Grey, Light Grey, Brown, Beige



Upholstered seat



Hale Stack Chair with upholstered seat



Hale Stack Chair Armrests with upholstered seat

Upholstered seat

Hale Stack Chair and Hale Stack Chair Armrests are also available with an upholstered seat. Please, find the surcharges on page 8.

Bespoke options

¹Specified costs are based on custom RAL colours as shown at devorm.nl in gloss degree 70%. Please, contact De Vorm for availability of the preferred colour. If the RAL colour is not in stock, there may be a price consequence.

²Specified costs are based on and only available in the following RAL fine texture colours: RAL 1012, RAL 3005, RAL 5008, RAL 5020, RAL 6007, RAL 6020, RAL 7015, RAL 7033, RAL 7044, RAL 7045, RAL 8014, RAL 9011. *These colours match perfectly with our PET Felt blends. See page 73 for ton-sur-ton colour combinations.*

Additional information

PET Felt is made of recycled material. Slight colour deviations may appear between different products.

Hale Series

	Seat + backrest	Qty	Frame Black/White	Frame Custom colour ¹	Frame Fine texture ²
Hale Counter Stool 	Dark Grey, Light Grey	1	€ 314,00	€ 336,00	€ 342,00
	Colour blends	1	€ 331,00	€ 353,00	€ 359,00

Hale Counter Stool Armrests 	Dark Grey, Light Grey	1	€ 347,00	€ 369,00	€ 375,00
	Colour blends	1	€ 355,00	€ 377,00	€ 383,00

Setup costs custom colour treatment (frame)

- Setup costs for the first colour are € 225,00
- Setup costs for every next colour are € 75,00

Measurements

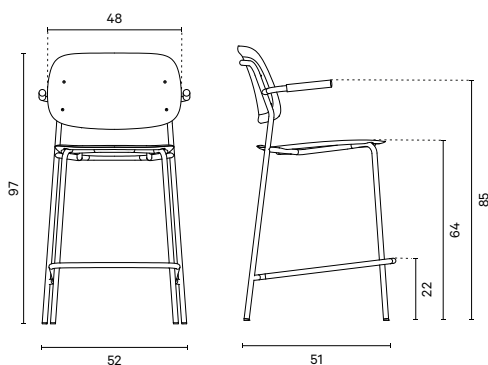

Specifications

Designed by	De Vorm & Ivan Kasner
Frame	Powder-coated steel
Standard frame colours	Black (RAL 9011) / White (RAL 9010) with 70% gloss degree
Seat + backrest	PET Felt
PET Felt blends	Marine, Turquoise, Olive, Dark Green, Green, Yellow, Pink, Dark Grey, Light Grey, Brown, Beige



Upholstered seat



Hale Counter Stool with upholstered seat



Hale Counter Stool Armrests with upholstered seat

Upholstered seat

Hale Counter Stool and Hale Counter Stool Armrests are also available with an upholstered seat. Please, find the surcharges on page 8.

Bespoke options

¹Specified costs are based on custom RAL colours as shown at devorm.nl in gloss degree 70%. Please, contact De Vorm for availability of the preferred colour. If the RAL colour is not in stock, there may be a price consequence.

²Specified costs are based on and only available in the following RAL fine texture colours: RAL 1012, RAL 3005, RAL 5008, RAL 5020, RAL 6007, RAL 6020, RAL 7015, RAL 7033, RAL 7044, RAL 7045, RAL 8014, RAL 9011. *These colours match perfectly with our PET Felt blends. See page 73 for ton-sur-ton colour combinations.*

Additional information

PET Felt is made of recycled material. Slight colour deviations may appear between different products.

Hale Series

Hale Bar Stool	Seat + backrest	Qty	Frame Black/White	Frame Custom colour ¹	Frame Fine texture ²
	Dark Grey, Light Grey	1	€ 314,00	€ 336,00	€ 342,00
	Colour blends	1	€ 331,00	€ 353,00	€ 359,00

	Dark Grey, Light Grey	1	€ 347,00	€ 369,00	€ 375,00
	Colour blends	1	€ 355,00	€ 377,00	€ 383,00

Setup costs custom colour treatment (frame)

- Setup costs for the first colour are € 225,00
- Setup costs for every next colour are € 75,00

Measurements

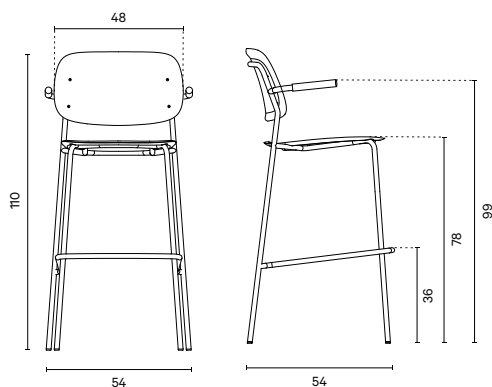

Specifications

Designed by	De Vorm & Ivan Kasner
Frame	Powder-coated steel
Standard frame colours	Black (RAL 9011) / White (RAL 9010) with 70% gloss degree
Seat + backrest	PET Felt
PET Felt blends	Marine, Turquoise, Olive, Dark Green, Green, Yellow, Pink, Dark Grey, Light Grey, Brown, Beige

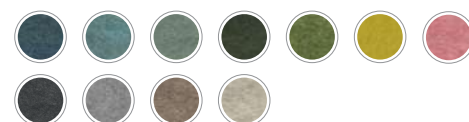

Upholstered seat

Hale Bar Stool and Hale Bar Stool Armrests are also available with an upholstered seat. Please, find the surcharges on page 8.

Upholstered seat



Hale Bar Stool
with upholstered seat



Hale Bar Stool Armrests with
upholstered seat

Bespoke options

¹Specified costs are based on custom RAL colours as shown at devorm.nl in gloss degree 70%. Please, contact De Vorm for availability of the preferred colour. If the RAL colour is not in stock, there may be a price consequence.

²Specified costs are based on and only available in the following RAL fine texture colours: RAL 1012, RAL 3005, RAL 5008, RAL 5020, RAL 6007, RAL 6020, RAL 7015, RAL 7033, RAL 7044, RAL 7045, RAL 8014, RAL 9011. *These colours match perfectly with our PET Felt blends. See page 73 for ton-sur-ton colour combinations.*

Additional information

PET Felt is made of recycled material. Slight colour deviations may appear between different products.

Hale Series

Hale Series Upholstered Seat



Hale Chair with upholstered seat



Hale Chair Armrests with upholstered seat



Hale Counter Stool with upholstered seat



Hale Counter Stool Armrests with upholstered seat



Hale Bar Stool with upholstered seat



Hale Bar Stool Armrests with upholstered seat

Qty	Fabric	Surcharge Ex. VAT
1 – 9	A	€ 190,00
	B	€ 198,00
	C	€ 207,00
	D	€ 215,00
	E	€ 223,00
	F	€ 231,00
10 – 24	A	€ 165,00
	B	€ 174,00
	C	€ 182,00
	D	€ 190,00
	E	€ 198,00
	F	€ 207,00
25 – 49	A	€ 149,00
	B	€ 157,00
	C	€ 165,00
	D	€ 174,00
	E	€ 182,00
	F	€ 190,00
> 50	A	€ 140,00
	B	€ 149,00
	C	€ 157,00
	D	€ 165,00
	E	€ 174,00
	F	€ 182,00

Find the overview of available fabrics on page 72.

LJ Series

LJ 1 Armchair



Shell	Qty	Frame Black/White	Frame Custom colour ¹	Frame Fine texture ²
Dark Grey, Light Grey	1	€ 298,00	€ 320,00	€ 326,00
Colour blends	1	€ 322,00	€ 344,00	€ 350,00

Setup costs custom colour treatment (frame)

- Setup costs for the first colour are € 225,00
- Setup costs for every next colour are € 75,00

Measurements

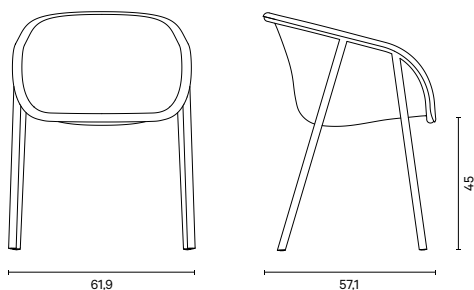

Specifications

Designed by	Laurens van Wieringen
Frame	Powder-coated steel
Standard frame colours	Black (RAL 9011) / White (RAL 9010) with 70% gloss degree
Shell	PET Felt
PET Felt blends	Marine, Turquoise, Olive, Dark Green, Green, Yellow, Pink, Dark Grey, Light Grey, Brown, Beige



Upholstered seat



Upholstered seat

LJ 1 Armchair is also available with an upholstered seat. Please, find the surcharges on page 13.

Bespoke options

¹Specified costs are based on custom RAL colours as shown at devorm.nl in gloss degree 70%. Please, contact De Vorm for availability of the preferred colour. If the RAL colour is not in stock, there may be a price consequence.

²Specified costs are based on and only available in the following RAL fine texture colours: RAL 1012, RAL 3005, RAL 5008, RAL 5020, RAL 6007, RAL 6020, RAL 7015, RAL 7033, RAL 7044, RAL 7045, RAL 8014, RAL 9011. *These colours match perfectly with our PET Felt blends. See page 73 for ton-sur-ton colour combinations.*

Additional information

PET Felt is made of recycled material. Slight colour deviations may appear between different products.

LJ Series

LJ 2 Stack Chair



Shell	Qty	Frame Black/White	Frame Custom colour ¹	Frame Fine texture ²
Dark Grey, Light Grey	1	€ 289,00	€ 311,00	€ 317,00
Colour blends	1	€ 306,00	€ 328,00	€ 334,00

Setup costs custom colour treatment (frame)

- Setup costs for the first colour are € 225,00
- Setup costs for every next colour are € 75,00

Measurements

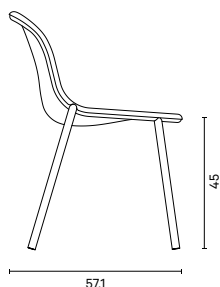
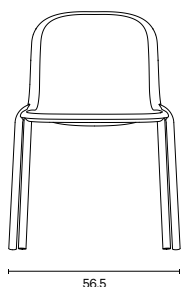

Specifications

Designed by	Laurens van Wieringen
Frame	Powder-coated steel
Standard frame colours	Black (RAL 9011) / White (RAL 9010) with 70% gloss degree
Shell	PET Felt
PET Felt blends	Marine, Turquoise, Olive, Dark Green, Green, Yellow, Pink, Dark Grey, Light Grey, Brown, Beige



Upholstered seat



Upholstered seat

LJ 2 Stack Chair is also available with an upholstered seat. Please, find the surcharges on page 13.

Bespoke options

¹Specified costs are based on custom RAL colours as shown at devorm.nl in gloss degree 70%. Please, contact De Vorm for availability of the preferred colour. If the RAL colour is not in stock, there may be a price consequence.

²Specified costs are based on and only available in the following RAL fine texture colours: RAL 1012, RAL 3005, RAL 5008, RAL 5020, RAL 6007, RAL 6020, RAL 7015, RAL 7033, RAL 7044, RAL 7045, RAL 8014, RAL 9011. *These colours match perfectly with our PET Felt blends. See page 73 for ton-sur-ton colour combinations.*

Additional information

PET Felt is made of recycled material. Slight colour deviations may appear between different products.

LJ Series

LJ 3 Bar Stool



Shell	Qty	Frame Black/White	Frame Custom colour ¹	Frame Fine texture ²
Dark Grey, Light Grey	1	€ 281,00	€ 303,00	€ 309,00
Colour blends	1	€ 314,00	€ 336,00	€ 342,00

Setup costs custom colour treatment (frame)

- Setup costs for the first colour are € 225,00
- Setup costs for every next colour are € 75,00

Measurements

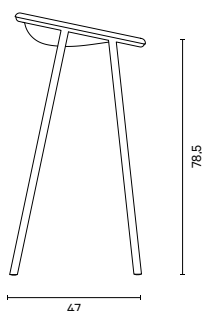
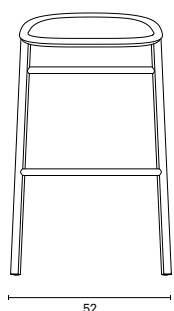

Specifications

Designed by	Laurens van Wieringen
Frame	Powder-coated steel
Standard frame colours	Black (RAL 9011) / White (RAL 9010) with 70% gloss degree
Shell	PET Felt
PET Felt blends	Marine, Turquoise, Olive, Dark Green, Green, Yellow, Pink, Dark Grey, Light Grey, Brown, Beige



Upholstered seat



Upholstered seat

LJ 3 Bar Stool is also available with an upholstered seat. Please, find the surcharges on page 13.

Bespoke options

¹Specified costs are based on custom RAL colours as shown at devorm.nl in gloss degree 70%. Please, contact De Vorm for availability of the preferred colour. If the RAL colour is not in stock, there may be a price consequence.

²Specified costs are based on and only available in the following RAL fine texture colours: RAL 1012, RAL 3005, RAL 5008, RAL 5020, RAL 6007, RAL 6020, RAL 7015, RAL 7033, RAL 7044, RAL 7045, RAL 8014, RAL 9011. *These colours match perfectly with our PET Felt blends. See page 73 for ton-sur-ton colour combinations.*

Additional information

PET Felt is made of recycled material. Slight colour deviations may appear between different products.

LJ Series

LJ 4 Counter Stool



Shell	Qty	Frame Black/White	Frame Custom colour ¹	Frame Fine texture ²
Dark Grey, Light Grey	1	€ 281,00	€ 303,00	€ 309,00
Colour blends	1	€ 314,00	€ 336,00	€ 342,00

Setup costs custom colour treatment (frame)

- Setup costs for the first colour are € 225,00
- Setup costs for every next colour are € 75,00

Measurements

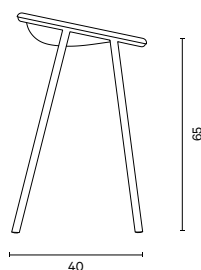
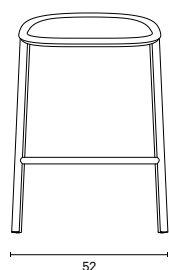

Specifications

Designed by	Laurens van Wieringen
Frame	Powder-coated steel
Standard frame colours	Black (RAL 9011) / White (RAL 9010) with 70% gloss degree
Shell	PET Felt
PET Felt blends	Marine, Turquoise, Olive, Dark Green, Green, Yellow, Pink, Dark Grey, Light Grey, Brown, Beige



Upholstered seat



Upholstered seat

LJ 4 Counter Stool is also available with an upholstered seat. Please, find the surcharges on page 13.

Bespoke options

¹Specified costs are based on custom RAL colours as shown at devorm.nl in gloss degree 70%. Please, contact De Vorm for availability of the preferred colour. If the RAL colour is not in stock, there may be a price consequence.

²Specified costs are based on and only available in the following RAL fine texture colours: RAL 1012, RAL 3005, RAL 5008, RAL 5020, RAL 6007, RAL 6020, RAL 7015, RAL 7033, RAL 7044, RAL 7045, RAL 8014, RAL 9011. *These colours match perfectly with our PET Felt blends. See page 73 for ton-sur-ton colour combinations.*

Additional information

PET Felt is made of recycled material. Slight colour deviations may appear between different products.

LJ Series

LJ Series Upholstered Seat



LJ 1 with upholstered seat



LJ 2 with upholstered seat



LJ 3 with upholstered seat



LJ 4 with upholstered seat

Qty	Fabric	Surcharge Ex. VAT
1 – 9	A	€ 190,00
	B	€ 198,00
	C	€ 207,00
	D	€ 215,00
	E	€ 223,00
	F	€ 231,00
10 – 24	A	€ 165,00
	B	€ 174,00
	C	€ 182,00
	D	€ 190,00
	E	€ 198,00
	F	€ 207,00
25 – 49	A	€ 149,00
	B	€ 157,00
	C	€ 165,00
	D	€ 174,00
	E	€ 182,00
	F	€ 190,00
> 50	A	€ 140,00
	B	€ 149,00
	C	€ 157,00
	D	€ 165,00
	E	€ 174,00
	F	€ 182,00

Find the overview of available fabrics on page 72.

Twist Series

Twist Stack Stool



Seat	Qty	Frame Black/White	Frame Custom colour ¹	Frame Fine texture ²
Dark Grey, Light Grey	1	€ 165,00	€ 187,00	€ 193,00
Colour blends	1	€ 177,00	€ 199,00	€ 205,00

Setup costs custom colour treatment (frame)

- Setup costs for the first colour are € 225,00
- Setup costs for every next colour are € 75,00

Measurements

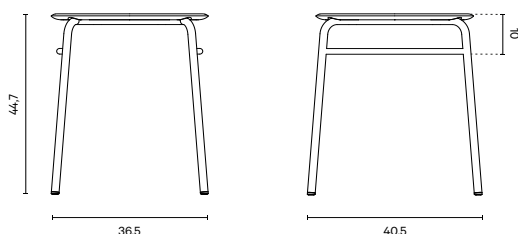

Specifications

Designed by	De Vorm
Frame	Powder-coated steel
Standard frame colours	Black (RAL 9011) / White (RAL 9010) with 70% gloss degree
Seat	PET Felt
PET Felt blends	Marine, Turquoise, Olive, Dark Green, Green, Yellow, Pink, Dark Grey, Light Grey, Brown, Beige



Upholstered seat



Upholstered seat

Twist Stack Stool is also available with an upholstered seat. Please, find the surcharges on page 17.

Bespoke options

¹Specified costs are based on custom RAL colours as shown at devorm.nl in gloss degree 70%. Please, contact De Vorm for availability of the preferred colour. If the RAL colour is not in stock, there may be a price consequence.

²Specified costs are based on and only available in the following RAL fine texture colours: RAL 1012, RAL 3005, RAL 5008, RAL 5020, RAL 6007, RAL 6020, RAL 7015, RAL 7033, RAL 7044, RAL 7045, RAL 8014, RAL 9011. *These colours match perfectly with our PET Felt blends. See page 73 for ton-sur-ton colour combinations.*

Additional information

PET Felt is made of recycled material. Slight colour deviations may appear between different products.

Twist Series

Twist Counter Stool



Seat	Qty	Frame Black/White	Frame Custom colour ¹	Frame Fine texture ²
Dark Grey, Light Grey	1	€ 207,00	€ 229,00	€ 235,00
Colour blends	1	€ 213,00	€ 235,00	€ 241,00

Setup costs custom colour treatment (frame)

- Setup costs for the first colour are € 225,00
- Setup costs for every next colour are € 75,00

Measurements

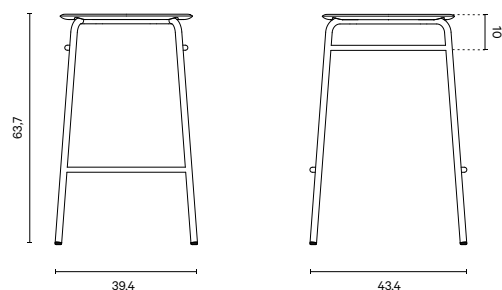

Specifications

Designed by	De Vorm
Frame	Powder-coated steel
Standard frame colours	Black (RAL 9011) / White (RAL 9010) with 70% gloss degree
Seat	PET Felt
PET Felt blends	Marine, Turquoise, Olive, Dark Green, Green, Yellow, Pink, Dark Grey, Light Grey, Brown, Beige



Upholstered seat



Upholstered seat

Twist Counter Stool is also available with an upholstered seat. Please, find the surcharges on page 17.

Bespoke options

¹Specified costs are based on custom RAL colours as shown at devorm.nl in gloss degree 70%. Please, contact De Vorm for availability of the preferred colour. If the RAL colour is not in stock, there may be a price consequence.

²Specified costs are based on and only available in the following RAL fine texture colours: RAL 1012, RAL 3005, RAL 5008, RAL 5020, RAL 6007, RAL 6020, RAL 7015, RAL 7033, RAL 7044, RAL 7045, RAL 8014, RAL 9011. *These colours match perfectly with our PET Felt blends. See page 73 for ton-sur-ton colour combinations.*

Additional information

PET Felt is made of recycled material. Slight colour deviations may appear between different products.

Twist Series

Twist Bar Stool



Seat	Qty	Frame Black/White	Frame Custom colour ¹	Frame Fine texture ²
Dark Grey, Light Grey	1	€ 207,00	€ 229,00	€ 235,00
Colour blends	1	€ 213,00	€ 235,00	€ 241,00

Setup costs custom colour treatment (frame)

- Setup costs for the first colour are € 225,00
- Setup costs for every next colour are € 75,00

Measurements

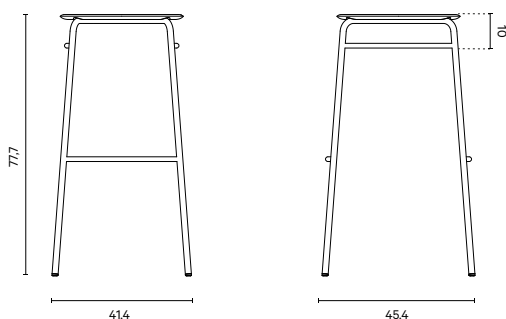

Specifications

Designed by	De Vorm
Frame	Powder-coated steel
Standard frame colours	Black (RAL 9011) / White (RAL 9010) with 70% gloss degree
Seat	PET Felt
PET Felt blends	Marine, Turquoise, Olive, Dark Green, Green, Yellow, Pink, Dark Grey, Light Grey, Brown, Beige

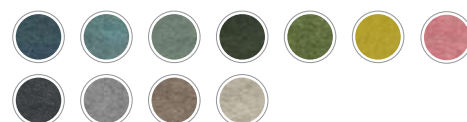

Upholstered seat



Upholstered seat

Twist Bar Stool is also available with an upholstered seat. Please, find the surcharges on page 17.

Bespoke options

¹Specified costs are based on custom RAL colours as shown at devorm.nl in gloss degree 70%. Please, contact De Vorm for availability of the preferred colour. If the RAL colour is not in stock, there may be a price consequence.

²Specified costs are based on and only available in the following RAL fine texture colours: RAL 1012, RAL 3005, RAL 5008, RAL 5020, RAL 6007, RAL 6020, RAL 7015, RAL 7033, RAL 7044, RAL 7045, RAL 8014, RAL 9011. *These colours match perfectly with our PET Felt blends. See page 73 for ton-sur-ton colour combinations.*

Additional information

PET Felt is made of recycled material. Slight colour deviations may appear between different products.

Twist Series

Twist Series Upholstered Seat

Qty Fabric Surcharge Ex. VAT

Twist Stack Stool
with upholstered seat

1 – 9	A	€ 165,00
	B	€ 174,00
	C	€ 182,00
	D	€ 190,00
	E	€ 198,00
	F	€ 207,00

Twist Counter Stool
with upholstered seat

10 – 24	A	€ 140,00
	B	€ 149,00
	C	€ 157,00
	D	€ 165,00
	E	€ 174,00
	F	€ 182,00

Twist Bar Stool
with upholstered seat

25 – 49	A	€ 124,00
	B	€ 132,00
	C	€ 140,00
	D	€ 149,00
	E	€ 157,00
	F	€ 165,00

> 50	A	€ 116,00
	B	€ 124,00
	C	€ 132,00
	D	€ 140,00
	E	€ 149,00
	F	€ 157,00

Find the overview of available fabrics on page 72.

Pod Privacy Chair



Shell	Fabric ¹	Frame Black/Clear ash	Frame Custom colour ²
Dark Grey, Light Grey	A	€ 3.058,00	€ 3.108,00
	B	€ 3.091,00	€ 3.141,00
	C	€ 3.124,00	€ 3.174,00
	D	€ 3.157,00	€ 3.207,00
	E	€ 3.190,00	€ 3.240,00
	F	€ 3.223,00	€ 3.273,00
Colour blends	A	€ 3.215,00	€ 3.265,00
	B	€ 3.248,00	€ 3.298,00
	C	€ 3.281,00	€ 3.331,00
	D	€ 3.306,00	€ 3.356,00
	E	€ 3.347,00	€ 3.397,00
	F	€ 3.397,00	€ 3.447,00

Surcharge custom lacquer colour treatment (frame)

- Setup costs for the first colour are € 225,00
- Setup costs for every next colour are € 75,00

Measurements

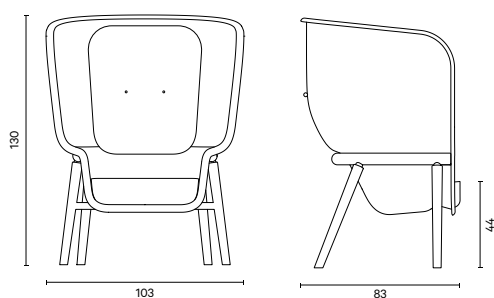

Specifications

Designed by	Benjamin Hubert
Frame	Solid ash
Shell	PET Felt
PET Felt blends	Marine, Turquoise, Olive, Dark Green, Green, Yellow, Pink, Dark Grey, Light Grey, Brown, Beige

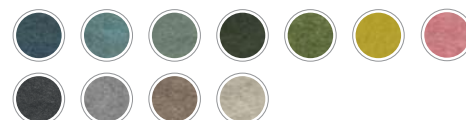

Bespoke options

1. Find the overview of available fabrics on page 72.
2. Specified costs are based on RAL colours as shown at devorm.nl in gloss degree 70%. Please, contact De Vorm for availability of the preferred colour. If the RAL colour is not in stock, there may be a price consequence.

Additional information

PET Felt is made of recycled material. Slight colour deviations may appear between different products.

Wood Me Chair



Qty	Fabric ¹	Frame Clear lacquer	Frame Custom colour ²
1	A	€ 653,00	€ 678,00
	B	€ 669,00	€ 694,00
	C	€ 686,00	€ 711,00
	D	€ 702,00	€ 727,00
	E	€ 719,00	€ 744,00
	F	€ 736,00	€ 761,00
	G	€ 777,00	€ 802,00
	H	€ 818,00	€ 843,00
50	Oak veneer seat and backrest ³	€ 665,00	€ 690,00

Availability based on stock levels. Please contact sales@devorm.nl for more information.

Surcharge custom lacquer colour treatment (frame)

When ordering less than 10 pieces in one custom frame colour, the extra € 150,00 setup costs apply.

Measurements

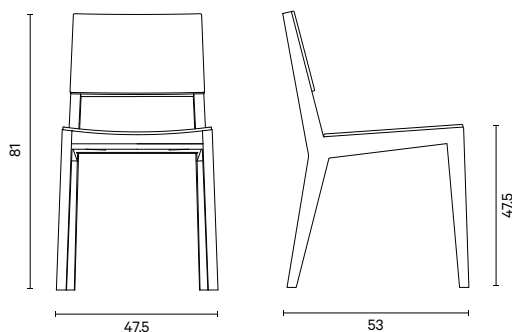

Specifications

Designed by	De Vorm
Frame	Solid oak
Seat + backrest	Upholstered

Bespoke options

¹ Find the overview of available fabrics on page 72.

² Specified costs are based on RAL colours as shown at devorm.nl in gloss degree 70%. Please, contact De Vorm for availability of the preferred colour. If the RAL colour is not in stock, there may be a price consequence.

³ Minimum order quantity for Wood Me Chair with oak veneer seat and backrest is 50 pieces. Please, contact De Vorm for more information.

Additional information

Wood Me Chair is a made-to-order product. The standard lead time is between 12 and 16 weeks.

Clip Chair Solid Ash Wood

	Qty	Fabric ¹	Frame Clear lacquer	Frame Custom colour ²
	1	A	€ 711,00	€ 736,00
		B	€ 719,00	€ 744,00
		C	€ 727,00	€ 752,00
		D	€ 736,00	€ 761,00
		E	€ 744,00	€ 769,00
		F	€ 760,00	€ 785,00
		G	€ 777,00	€ 802,00
		H	€ 884,00	€ 909,00
	50	Solid ash seat ³	€ 785,00	€ 810,00

Availability based on stock levels. Please contact sales@devorm.nl for more information.

Surcharge custom lacquer colour treatment (frame)

When ordering less than 10 pieces in one custom frame colour, the extra € 150,00 setup costs apply.

Measurements

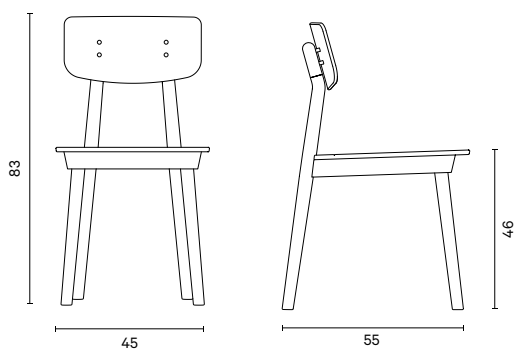

Specifications

Designed by	Sebastian Herkner
Frame	Solid ash
Seat	Upholstered

Bespoke options

¹ Find the overview of available fabrics on page 72.

² Specified costs are based on RAL colours as shown at devorm.nl in gloss degree 70%. Please, contact De Vorm for availability of the preferred colour. If the RAL colour is not in stock, there may be a price consequence.

³ Minimum order quantity for Clip Chair with solid ash seat is 50 pieces. Please, contact De Vorm for more information.

Additional information

Clip Chair is a made-to-order product. The standard lead time is between 12 and 16 weeks.

Slim M Stack Chair

	Qty	Frame Chrome	Frame Custom colour ¹	Frame Fine texture ²	
	Veneer seat	1	€ 195,00	€ 217,00	€ 223,00
	Custom colour seat ³	50	€ 220,00	€ 242,00	€ 248,00

Availability based on stock levels. Please contact sales@devorm.nl for more information.

Setup costs custom colour treatment (frame)

- Setup costs for the first colour are € 225,00
- Setup costs for every next colour are € 75,00

Measurements

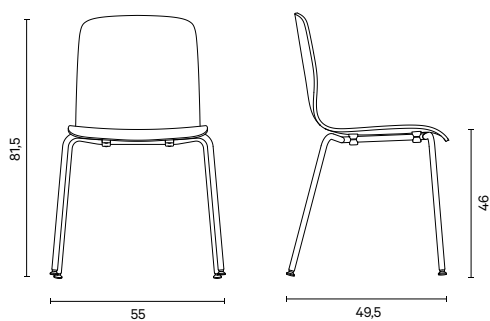

Specifications

Designed by	Sebastian Herkner
Frame	Chrome
Seat	Oak veneer

Bespoke options

¹Specified costs are based on custom RAL colours as shown at devorm.nl in gloss degree 70%. Please, contact De Vorm for availability of the preferred colour. If the RAL colour is not in stock, there may be a price consequence.

²Specified costs are based on and only available in the following RAL fine texture colours: RAL 1012, RAL 3005, RAL 5008, RAL 5020, RAL 6007, RAL 6020, RAL 7015, RAL 7033, RAL 7044, RAL 7045, RAL 8014, RAL 9011.

³Minimum order quantity for Slim M with a custom lacquered seat colour is 50 pieces. Please, contact De Vorm for more information.

Lounge Chairs

Hale Lounge Chair

	Seat + backrest	Qty	Frame Black/White	Frame Custom colour ¹	Frame Fine texture ²
Hale Lounge Chair 	Dark Grey, Light Grey	1	€ 331,00	€ 353,00	€ 359,00
	Colour blends	1	€ 364,00	€ 386,00	€ 392,00

Hale Lounge Chair Armrests 	Dark Grey, Light Grey	1	€ 380,00	€ 402,00	€ 408,00
	Colour blends	1	€ 397,00	€ 419,00	€ 425,00

Setup costs custom colour treatment (frame)

- Setup costs for the first colour are € 225,00
- Setup costs for every next colour are € 75,00

Measurements

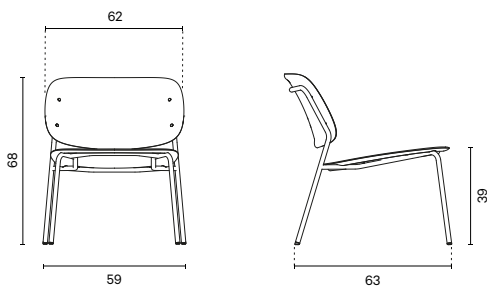

Specifications

Designed by	De Vorm
Frame	Powder-coated steel
Standard frame colours	Black (RAL 9011) / White (RAL 9010) with 70% gloss degree
Seat + backrest	PET Felt
PET Felt blends	Marine, Turquoise, Olive, Dark Green, Green, Yellow, Pink, Dark Grey, Light Grey, Brown, Beige

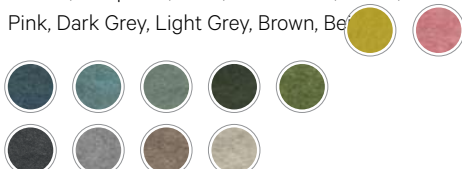

Upholstered seat



Hale Lounge Chair with upholstered seat

Hale Lounge Chair Armrests with upholstered seat

Upholstered seat

Hale Lounge Chair and Hale Lounge Chair Armrests are also available with an upholstered seat. Please, find the surcharges on page 24.

Bespoke options

¹Specified costs are based on custom RAL colours as shown at devorm.nl in gloss degree 70%. Please, contact De Vorm for availability of the preferred colour. If the RAL colour is not in stock, there may be a price consequence.

²Specified costs are based on and only available in the following RAL fine texture colours: RAL 1012, RAL 3005, RAL 5008, RAL 5020, RAL 6007, RAL 6020, RAL 7015, RAL 7033, RAL 7044, RAL 7045, RAL 8014, RAL 9011. *These colours match perfectly with our PET Felt blends. See page 73 for ton-sur-ton colour combinations.*

Additional information

PET Felt is made of recycled material. Slight colour deviations may appear between different products.

Hale Lounge Chair

Hale Lounge Chair Upholstered Seat



Hale Lounge Chair with upholstered seat



Hale Lounge Chair Armrests with upholstered seat

Qty	Fabric	Surcharge Ex. VAT
1 – 9	A	€ 231,00
	B	€ 240,00
	C	€ 248,00
	D	€ 256,00
	E	€ 264,00
	F	€ 273,00
10 – 24	A	€ 207,00
	B	€ 215,00
	C	€ 223,00
	D	€ 231,00
	E	€ 240,00
	F	€ 248,00
25 – 49	A	€ 190,00
	B	€ 198,00
	C	€ 207,00
	D	€ 215,00
	E	€ 223,00
	F	€ 231,00
> 50	A	€ 182,00
	B	€ 190,00
	C	€ 198,00
	D	€ 207,00
	E	€ 215,00
	F	€ 223,00

Find the overview of available fabrics on page 72.

Nook Lounge Chair

Shell	Fabric	Frame Black/White	Frame Custom colour ¹	Frame Fine texture ²	
	Dark Grey, Light Grey	A Upon request	–	–	
		B	€ 1.155,00	€ 1.180,00	€ 1.187,00
		C	€ 1.198,00	€ 1.223,00	€ 1.230,00
		D	€ 1.248,00	€ 1.273,00	€ 1.280,00
		E	€ 1.273,00	€ 1.298,00	€ 1.305,00
		F	€ 1.298,00	€ 1.323,00	€ 1.330,00
		G	€ 1.322,00	€ 1.347,00	€ 1.354,00
		H	€ 1.405,00	€ 1.430,00	€ 1.437,00
	Colour blends	A Upon request	–	–	–
		B	€ 1.314,00	€ 1.339,00	€ 1.346,00
		C	€ 1.339,00	€ 1.364,00	€ 1.371,00
		D	€ 1.347,00	€ 1.372,00	€ 1.379,00
		E	€ 1.380,00	€ 1.405,00	€ 1.412,00
		F	€ 1.405,00	€ 1.430,00	€ 1.437,00
		G	€ 1.463,00	€ 1.488,00	€ 1.495,00
		H	€ 1.521,00	€ 1.546,00	€ 1.553,00

Setup costs custom colour treatment (frame)

- Setup costs for the first colour are € 225,00
- Setup costs for every next colour are € 75,00

Measurements

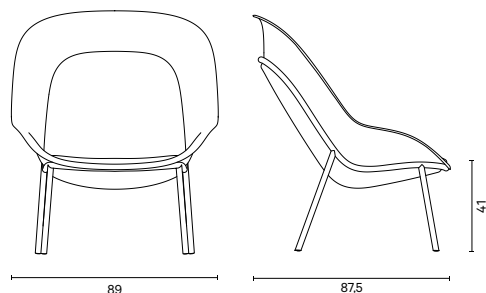

Specifications

Designed by	Johan van Hengel
Frame	Powder-coated steel
Standard frame colours	Black (RAL 9011) / White (RAL 9010) with 70% gloss degree
Shell	PET Felt
PET Felt blends	Marine, Turquoise, Olive, Dark Green, Green, Yellow, Pink, Dark Grey, Light Grey, Brown, Beige

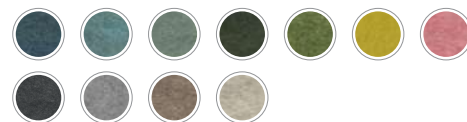

Bespoke options

¹Find the overview of available fabrics on page 72.

²Specified costs are based on custom RAL colours as shown at devorm.nl in gloss degree 70%. Please, contact De Vorm for availability of the preferred colour. If the RAL colour is not in stock, there may be a price consequence.

³Specified costs are based on and only available in the following RAL fine texture colours: RAL 1012, RAL 3005, RAL 5008, RAL 5020, RAL 6007, RAL 6020, RAL 7015, RAL 7033, RAL 7044, RAL 7045, RAL 8014, RAL 9011. *These colours match perfectly with our PET Felt blends. See page 73 for ton-sur-ton colour combinations.*

Additional information

PET Felt is made of recycled material. Slight colour deviations may appear between different products.

Wood Me Lounge Chair



Qty	Fabric ¹	Frame Clear lacquer	Frame Custom colour ²
1	A	€ 785,00	€ 810,00
	B	€ 802,00	€ 827,00
	C	€ 818,00	€ 843,00
	D	€ 835,00	€ 860,00
	E	€ 851,00	€ 876,00
	F	€ 868,00	€ 893,00
	G	€ 950,00	€ 975,00
	H	€ 983,00	€ 1.008,00
50	Oak veneer seat and backrest ³	€ 686,00	€ 711,00

Availability based on stock levels. Please contact sales@devorm.nl for more information.

Surcharge custom lacquer colour treatment (frame)

When ordering less than 10 pieces in one custom frame colour, the extra € 150,00 setup costs apply.

Measurements

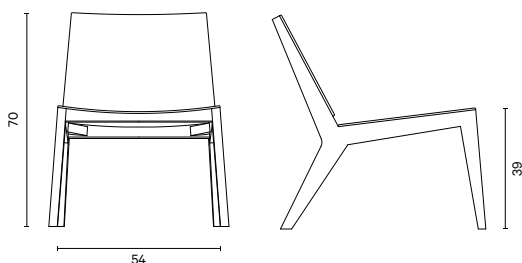

Specifications

Designed by	De Vorm
Frame	Solid oak
Seat + backrest	Upholstered

Bespoke options

¹ Find the overview of available fabrics on page 72.

² Specified costs are based on RAL colours as shown at devorm.nl in gloss degree 70%. Please, contact De Vorm for availability of the preferred colour. If the RAL colour is not in stock, there may be a price consequence.

³ Minimum order quantity for Wood Me Chair with oak veneer seat and backrest is 50 pieces. Please, contact De Vorm for more information.

Additional information

Wood Me Lounge Chair is a made-to-order product. The standard lead time is between 12 and 16 weeks.

Daddy's Lounge Chair



Qty	Fabric ¹	Armrests Clear oak/Walnut	Armrests Custom colour ²
1	A	€ 1.810,00	€ 1.860,00
	B	€ 1.893,00	€ 1.943,00
	C	€ 1.975,00	€ 2.025,00
	D	€ 2.058,00	€ 2.108,00
	E	€ 2.140,00	€ 2.190,00
	F	€ 2.223,00	€ 2.273,00
	G	€ 2.306,00	€ 2.356,00
	H	€ 2.471,00	€ 2.521,00

Measurements

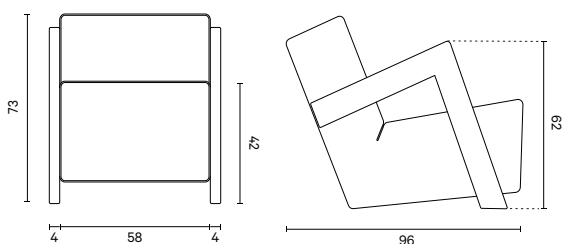

Specifications

Designed by	De Vorm
Armrests	Solid oak or walnut
Body	Upholstered

Bespoke options

¹ Find the overview of available fabrics on page 72.

² The armrests can be customised in a custom RAL colour with a lacquer treatment. Specified costs are based on RAL colours as shown at devorm.nl in gloss degree 70%. Please, contact De Vorm for availability of the preferred colour. If the RAL colour is not in stock, there may be a price consequence.

Couches

DeVorm

Arnhem Series

Arnhem Sofa Modular Couch

Fabric

Ex. VAT

Arnhem Sofa 71



A	€ 3.967,00
B	€ 4.132,00
C	€ 4.298,00
D	€ 4.463,00
E	€ 4.628,00
F	€ 4.793,00

Arnhem Sofa 94



A	€ 4.463,00
B	€ 4.628,00
C	€ 4.793,00
D	€ 4.959,00
E	€ 5.289,00
F	€ 5.785,00

Arnhem Sofa 118



A	€ 4.959,00
B	€ 5.289,00
C	€ 5.455,00
D	€ 5.620,00
E	€ 5.785,00
F	€ 6.116,00

Arnhem Sofa 141



A	€ 5.289,00
B	€ 5.455,00
C	€ 5.620,00
D	€ 5.785,00
E	€ 6.281,00
F	€ 6.612,00

Measurements

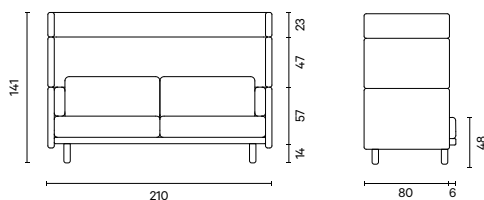

Specifications

Designed by	Sebastian Herkner	
Body + cushions	Upholstered	
Legs	Solid oak or ash, clear-lacquered	no surcharge
	Sled (Powder-coated steel, Black RAL 9011)	€ 157,00
	Angled (Powder-coated steel, Black RAL 9011)	€ 223,00

Arnhem Series Legs



Solid oak /
solid ash legs



Sled legs



Angled legs

Bespoke options

The colour of the legs can be customised.

Extra costs for custom colour treatment per set of 4 solid wooden oak or ash legs are **€ 25,00** ex VAT.

Extra costs for colour treatment per set of the angled or sled legs are **€ 75,00** ex VAT. Specified costs are based on RAL colours as shown at devorm.nl in gloss degree 70%. Please, contact De Vorm for availability of the preferred colour. If the RAL colour is not on stock, there can be a price consequence.

Additional information

Find the overview of available fabrics on page 72. The prices in this list are based on ordering Arnhem Sofa in one fabric type in one or two colours. For prices of other combinations, please, contact De Vorm.

Arnhem Series

Arnhem Loveseat Modular Couch

Fabric

Ex. VAT

Arnhem Loveseat 71



A	€ 2.686,00
B	€ 2.810,00
C	€ 2.934,00
D	€ 3.058,00
E	€ 3.306,00
F	€ 3.471,00

Arnhem Loveseat 94



A	€ 3.306,00
B	€ 3.471,00
C	€ 3.636,00
D	€ 3.802,00
E	€ 3.967,00
F	€ 4.132,00

Arnhem Loveseat 118



A	€ 3.636,00
B	€ 3.802,00
C	€ 3.967,00
D	€ 4.132,00
E	€ 4.298,00
F	€ 4.463,00

Arnhem Loveseat 141



A	€ 3.802,00
B	€ 4.132,00
C	€ 4.463,00
D	€ 4.793,00
E	€ 4.876,00
F	€ 4.959,00

Measurements

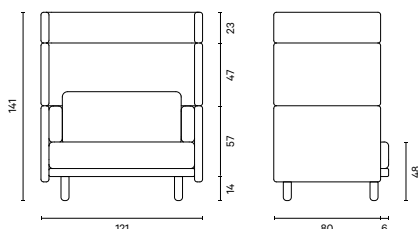

Specifications

Designed by	Sebastian Herkner	
Body + cushions	Upholstered	
Legs	Solid oak or ash, clear-lacquered	no surcharge
	Sled (Powder-coated steel, Black RAL 9011)	€ 157,00
	Angled (Powder-coated steel, Black RAL 9011)	€ 223,00

Bespoke options

The colour of the legs can be customised.

Extra costs for custom colour treatment per set of 4 solid wooden oak or ash legs are **€ 25,00** ex VAT.

Extra costs for colour treatment per set of the angled or sled legs are **€ 75,00** ex VAT. Specified costs are based on RAL colours as shown at devorm.nl in gloss degree 70%. Please, contact De Vorm for availability of the preferred colour. If the RAL colour is not on stock, there can be a price consequence.

Arnhem Series Legs



Solid oak /
solid ash legs



Sled legs



Angled legs

Additional information

Find the overview of available fabrics on page 72. The prices in this list are based on ordering Arnhem Loveseat in one fabric type in one or two colours. For prices of other combinations, please, contact De Vorm.

Arnhem Series

Arnhem Sofa Goes Room

Fabric

Ex. VAT

Arnhem Sofa Goes Room 71



A	€ 3.595,00
B	€ 3.884,00
C	€ 4.050,00
D	€ 4.215,00
E	€ 4.380,00
F	€ 4.711,00

Arnhem Sofa Goes Room 94



A	€ 4.215,00
B	€ 4.545,00
C	€ 4.711,00
D	€ 4.876,00
E	€ 5.041,00
F	€ 5.537,00

Arnhem Sofa Goes Room 118



A	€ 4.628,00
B	€ 5.041,00
C	€ 5.289,00
D	€ 5.455,00
E	€ 5.785,00
F	€ 6.033,00

Arnhem Sofa Goes Room 141



A	€ 5.207,00
B	€ 5.702,00
C	€ 5.950,00
D	€ 6.198,00
E	€ 6.446,00
F	€ 6.860,00

Measurements

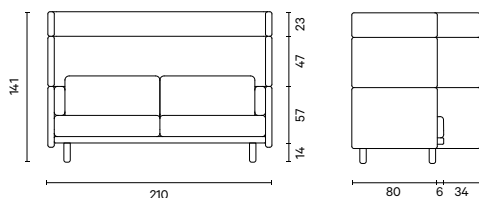

Specifications

Designed by	Sebastian Herkner
Body + cushions	Upholstered
Legs	Solid oak or ash, clear-lacquered no surcharge
	Sled (Powder-coated steel, Black RAL 9011) € 157,00
	Angled (Powder-coated steel, Black RAL 9011) € 223,00

Bespoke options

The colour of the legs can be customised.

Extra costs for custom colour treatment per set of 4 solid wooden oak or ash legs are **€ 25,00** ex VAT.

Extra costs for colour treatment per set of the angled or sled legs are **€ 75,00** ex VAT. Specified costs are based on RAL colours as shown at devorm.nl in gloss degree 70%. Please, contact De Vorm for availability of the preferred colour. If the RAL colour is not on stock, there can be a price consequence.

Arnhem Series Legs



Solid oak /
solid ash legs

Sled legs

Angled legs

Additional information

Find the overview of available fabrics on page 72. The prices in this list are based on ordering Arnhem Sofa Goes Room in one fabric type in one or two colours.

For prices of other combinations, please, contact De Vorm.

Arnhem Series

Arnhem Loveseat Goes Room	Fabric	Ex. VAT
Arnhem Loveseat Goes Room 71 	A	€ 2.893,00
	B	€ 2.975,00
	C	€ 3.058,00
	D	€ 3.140,00
	E	€ 3.223,00
	F	€ 3.595,00
Arnhem Loveseat Goes Room 94 	A	€ 3.430,00
	B	€ 3.595,00
	C	€ 3.760,00
	D	€ 3.926,00
	E	€ 4.091,00
	F	€ 4.256,00
Arnhem Loveseat Goes Room 118 	A	€ 3.678,00
	B	€ 3.843,00
	C	€ 4.008,00
	D	€ 4.174,00
	E	€ 4.339,00
	F	€ 4.504,00
Arnhem Loveseat Goes Room 141 	A	€ 4.174,00
	B	€ 4.339,00
	C	€ 4.504,00
	D	€ 4.669,00
	E	€ 4.835,00
	F	€ 5.083,00

Measurements

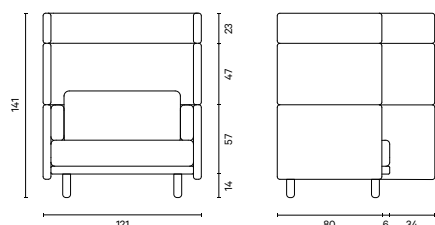

Specifications

Designed by	Sebastian Herkner	
Body + cushions	Upholstered	
Legs	Solid oak or ash, clear-lacquered	no surcharge
	Sled (Powder-coated steel, Black RAL 9011)	€ 157,00
	Angled (Powder-coated steel, Black RAL 9011)	€ 223,00

Bespoke options

The colour of the legs can be customised.

Extra costs for custom colour treatment per set of 4 solid wooden oak or ash legs are **€ 25,00** ex VAT.

Extra costs for colour treatment per set of the angled or sled legs are **€ 75,00** ex VAT. Specified costs are based on RAL colours as shown at devorm.nl in gloss degree 70%. Please, contact De Vorm for availability of the preferred colour. If the RAL colour is not on stock, there can be a price consequence.

Arnhem Series Legs



Solid oak /
solid ash legs

Sled legs

Angled legs

Additional information

Find the overview of available fabrics on page 72. The prices in this list are based on ordering Arnhem Loveseat Goes Room in one fabric type in one or two colours. For prices of other combinations, please, contact De Vorm.

Upside Down Series

Upside Down Couch	Fabric	Ex. VAT
Upside Down Couch 205 	A	€ 3.140,00
	B	€ 3.306,00
	C	€ 3.471,00
	D	€ 3.636,00
	E	€ 3.802,00
	F	€ 3.967,00
Upside Down Couch 235 	A	€ 3.306,00
	B	€ 3.471,00
	C	€ 3.636,00
	D	€ 3.802,00
	E	€ 3.967,00
	F	€ 4.132,00
Upside Down Couch 265 	A	€ 3.554,00
	B	€ 3.719,00
	C	€ 3.884,00
	D	€ 4.050,00
	E	€ 4.215,00
	F	€ 4.380,00

Measurements

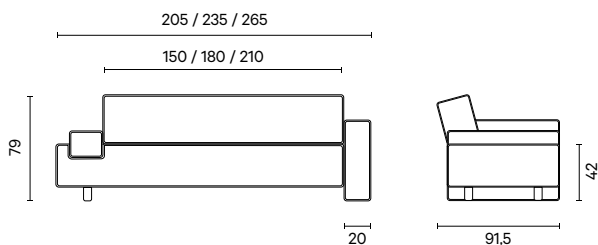

Upside Down Legs

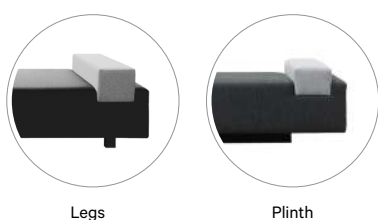

Legs

Plinth

Specifications

Designed by	De Vorm	
Body + armrest	Upholstered	
Legs	Solid oak or walnut, clear-lacquered	no surcharge
Plinth	Upholstered	€ 215,00

Bespoke options

The colour of the legs can be customised. Extra costs for custom colour treatment per set of legs are € 25,00 ex VAT. Specified costs are based on RAL colours as shown at devorm.nl in gloss degree 70%. Please, contact De Vorm for availability of the preferred colour. If the RAL colour is not in stock, there may be a price consequence.

Additional information

Find the overview of available fabrics on page 72.

The prices in this list are based on ordering Upside Down Couch in one colour or with the rotatable armrest in a different colour of the same fabric type. For prices of other combinations, please, contact De Vorm.

Upside Down Series

Upside Down Island	Fabric	Ex. VAT
Upside Down Island 185 	A	€ 2.066,00
	B	€ 2.149,00
	C	€ 2.231,00
	D	€ 2.314,00
	E	€ 2.397,00
	F	€ 2.479,00
Upside Down Island 215 	A	€ 2.231,00
	B	€ 2.314,00
	C	€ 2.397,00
	D	€ 2.479,00
	E	€ 2.562,00
	F	€ 2.645,00
Upside Down Island 245 	A	€ 2.397,00
	B	€ 2.479,00
	C	€ 2.562,00
	D	€ 2.645,00
	E	€ 2.727,00
	F	€ 2.810,00

Measurements

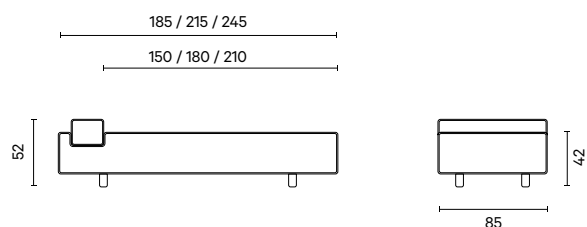

Upside Down Legs

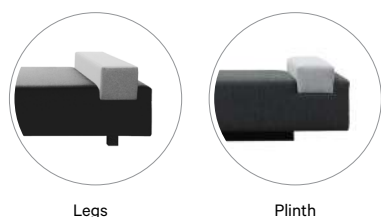

Specifications

Designed by	De Vorm	
Body + armrest	Upholstered	
Legs	Solid oak or walnut, clear-lacquered	no surcharge
Plinth	Upholstered	€ 215,00

Bespoke options

The colour of the legs can be customised. Extra costs for custom colour treatment per set of legs are € 25,00 ex VAT. Specified costs are based on RAL colours as shown at devorm.nl in gloss degree 70%. Please, contact De Vorm for availability of the preferred colour. If the RAL colour is not in stock, there may be a price consequence.

Additional information

Find the overview of available fabrics on page 72.

The prices in this list are based on ordering Upside Down Island in one colour or with the rotatable armrest in a different colour of the same fabric type. For prices of other combinations, please, contact De Vorm.

Florian Series

	Qty	Fabric ¹	Frame Black	Frame Custom colour ²	Frame Fine texture ³
Florian Chair 	1	A	€ 636,00	€ 711,00	€ 736,00
		B	€ 669,00	€ 744,00	€ 769,00
		C	€ 686,00	€ 761,00	€ 786,00
		D	€ 702,00	€ 777,00	€ 802,00
		E	€ 719,00	€ 794,00	€ 819,00
		F	€ 736,00	€ 811,00	€ 836,00
		G	€ 777,00	€ 852,00	€ 877,00
		H	€ 909,00	€ 984,00	€ 1.009,00

Florian Bench 	1	A	€ 975,00	€ 1.050,00	€ 1.075,00
		B	€ 1.025,00	€ 1.100,00	€ 1.125,00
		C	€ 1.066,00	€ 1.141,00	€ 1.166,00
		D	€ 1.107,00	€ 1.182,00	€ 1.207,00
		E	€ 1.149,00	€ 1.224,00	€ 1.249,00
		F	€ 1.190,00	€ 1.265,00	€ 1.290,00
		G	€ 1.231,00	€ 1.306,00	€ 1.331,00
		H	€ 1.364,00	€ 1.439,00	€ 1.464,00

Measurements Florian Chair

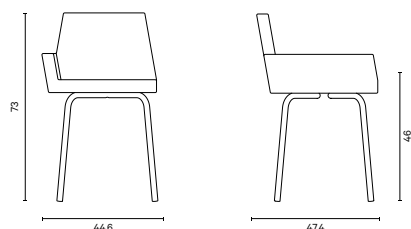

Measurements Florian Bench

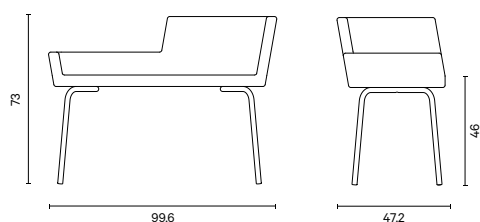

Specifications

Designed by	Laurens van Wieringen
Frame	Powder-coated steel
Standard frame colour	Black (RAL 9011) with 70% gloss degree
Body	Upholstered



Bespoke options

¹Find the overview of available fabrics on page 72.

²Specified costs are based on custom RAL colours as shown at devorm.nl in gloss degree 70%. Please, contact De Vorm for availability of the preferred colour. If the RAL colour is not in stock, there may be a price consequence.

³Specified costs are based on and only available in the following RAL fine texture colours: RAL 1012, RAL 3005, RAL 5008, RAL 5020, RAL 6007, RAL 6020, RAL 7015, RAL 7033, RAL 7044, RAL 7045, RAL 8014, RAL 9011.

Mino Sofa Series

	Fabric ¹	Frame Black	Frame Custom colour ²	Frame Fine texture ³
Mino Sofa One Seat				
	A	€ 1.542,00	€ 1.642,00	€ 1.683,00
	B	€ 1.600,00	€ 1.700,00	€ 1.733,00
	C	€ 1.683,00	€ 1.783,00	€ 1.817,00
	D	€ 1.792,00	€ 1.817,00	€ 1.917,00
	E	€ 1.917,00	€ 2.025,00	€ 2.058,00
	F	€ 2.158,00	€ 2.258,00	€ 2.292,00
Mino Sofa Two Seats				
	A	€ 2.375,00	€ 2.517,00	€ 2.567,00
	B	€ 2.433,00	€ 2.575,00	€ 2.625,00
	C	€ 2.592,00	€ 2.733,00	€ 2.783,00
	D	€ 2.708,00	€ 2.917,00	€ 2.967,00
	E	€ 2.967,00	€ 3.108,00	€ 3.158,00
	F	€ 3.350,00	€ 3.483,00	€ 3.533,00
Mino Sofa Three Seats				
	A	€ 2.817,00	€ 2.983,00	€ 3.025,00
	B	€ 2.875,00	€ 3.033,00	€ 3.083,00
	C	€ 2.975,00	€ 3.133,00	€ 3.200,00
	D	€ 3.150,00	€ 3.250,00	€ 3.417,00
	E	€ 3.383,00	€ 3.542,00	€ 3.608,00
	F	€ 3.792,00	€ 3.950,00	€ 4.017,00

Mino Sofa Series is available from Q1 2023

Measurements

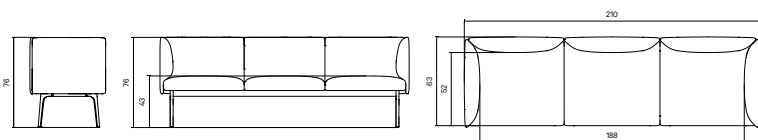
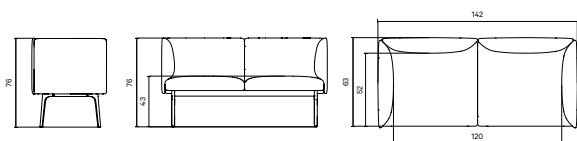
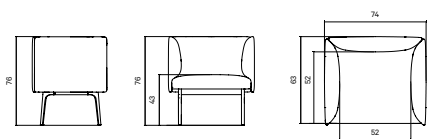

Specifications

Designed by	KLINGERBORDIHN
Frame	Powder-coated aluminium + steel
Standard frame colour	Black
Body	Upholstered

Bespoke options

¹Find the overview of available fabrics on page 72.

²Specified costs are based on custom RAL colours as shown at devorm.nl in gloss degree 70%. Please, contact De Vorm for availability of the preferred colour. If the RAL colour is not in stock, there may be a price consequence.

³Specified costs are based on and only available in the following RAL fine texture colours: RAL 1012, RAL 3005, RAL 5008, RAL 5020, RAL 6007, RAL 6020, RAL 7015, RAL 7033, RAL 7044, RAL 7045, RAL 8014, RAL 9011.

Tables

Big Modular Table System

	Length	Width	Big 74	Big 95	Big 110
Prices as mentioned on the right are indications based on the smallest length and depth, a 28 mm MDF core with an HPL Duropal U11026 finish, straight edges, a matching edgeband and rounded corners with 60 mm radius.	160 – 219	130 – 200	€ 2.140,00	€ 2.193,00	€ 2.232,00
	220 – 279	130 – 200	€ 2.433,00	€ 2.487,00	€ 2.526,00
	280 – 297	130 – 200	€ 3.462,00	€ 3.516,00	€ 3.555,00
Exact prices depend on length, width, height, finish of the table top and the ordered quantity.	298 – 339	90 – 200	€ 2.932,00	€ 2.986,00	€ 3.025,00
	340 – 399	90 – 200	€ 3.164,00	€ 3.217,00	€ 3.256,00
	400 – 459	90 – 200	€ 3.473,00	€ 3.527,00	€ 3.566,00
Please, contact De Vorm for the exact quotation.	460 – 519	90 – 200	€ 3.700,00	€ 3.754,00	€ 3.793,00
	520 – 579	90 – 200	€ 3.913,00	€ 3.966,00	€ 4.005,00
	580 – 639	90 – 200	€ 4.877,00	€ 4.957,00	€ 5.016,00
Note For tables with a length of 160 – 297 cm and a width less than 131 cm, see our Lite Modular Table System (page 39).	640 – 699	90 – 200	€ 5.222,00	€ 5.302,00	€ 5.360,00
	700 – 759	90 – 200	€ 5.434,00	€ 5.514,00	€ 5.572,00
	760 – 819	90 – 200	€ 5.702,00	€ 5.782,00	€ 5.841,00
	820 – 879	90 – 200	€ 6.235,00	€ 6.315,00	€ 6.373,00
	880 – 939	90 – 200	€ 7.009,00	€ 7.116,00	€ 7.194,00
	940 – 1000	90 – 200	€ 7.188,00	€ 7.295,00	€ 7.373,00

Leg options

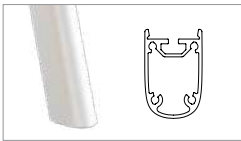

Anodised legs



Steel legs

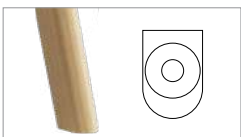

Solid oak legs



Specifications

Standard frame & legs	Anodised aluminium (VOM1 Natural)
Height	74 / 95 / 110 cm

Bespoke options

- De Vorm offers the possibility to customise the legs of the Big Table:
 - Solid oak legs for Big 74 no surcharge
 - Powder-coated steel legs, Black (RAL 9011) no surcharge
 - Anodised or steel legs in custom RAL colour* € 40,00
 - Anodised or steel legs in Fine texture* € 50,00

Fine texture is only available in the following RAL colours: RAL 1012, RAL 3005, RAL 5008, RAL 5020, RAL 6007, RAL 6020, RAL 7015, RAL 7033, RAL 7044, RAL 7045, RAL 8014, RAL 9011.

 - * Setup costs for the first custom colour € 225,00
 - Setup costs for every next custom colour € 75,00
- De Vorm offers a variety of tabletop options:
 - 28 mm MDF core + HPL, veneer, Fenix or Desktop top layer
 - 27 mm Plywood core + HPL, veneer, Fenix or Desktop top layer
 - Diverse edge finishes

Please, contact De Vorm for more information about available options.
- Tabletop can be equipped with cable cubbies. Find our standard cable cubby options on page 42.

Big Round Modular Table System

	Ø Table top	Big Round 74	Big Round 95	Big Round 110
Prices as mentioned on the right are indications based on the smallest length and depth, a 28 mm MDF core with an HPL Duropal U11026 finish, straight edges, and a matching edgeband.	160	€ 2.950,00	€ 2.988,00	€ 3.017,00
	170	€ 2.985,00	€ 3.023,00	€ 3.051,00
	180	€ 3.097,00	€ 3.135,00	€ 3.163,00
	190	€ 3.221,00	€ 3.259,00	€ 3.288,00
	200	€ 3.257,00	€ 3.295,00	€ 3.324,00
Prices depend on the diameter, finish of the table top and the ordered quantity.	210	€ 3.520,00	€ 3.558,00	€ 3.586,00
	220	€ 3.630,00	€ 3.667,00	€ 3.696,00
	230	€ 3.724,00	€ 3.762,00	€ 3.790,00
Please, contact De Vorm for the exact quotation.	240	€ 3.764,00	€ 3.802,00	€ 3.831,00
	250	€ 4.004,00	€ 4.042,00	€ 4.071,00

Note

For tables with a diameter of 120 – 159 cm, see our Lite Round Modular Table System (page 40).

Leg options

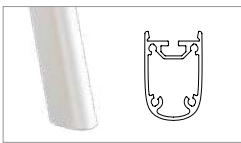

Anodised legs



Steel legs

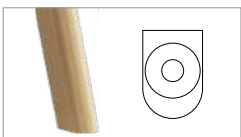

Solid oak legs



Specifications

Standard frame & legs	Anodised aluminium (VOM1 Natural)
Height	74 / 95 / 110 cm

Bespoke options

- De Vorm offers the possibility to customise the legs of the Big Round Table:
 - Solid oak legs for Big Round 74 no surcharge
 - Powder-coated steel legs, Black (RAL 9011) no surcharge
 - Anodised or steel legs in custom RAL colour* € 40,00
 - Anodised or steel legs in Fine texture* € 50,00

Fine texture is only available in the following RAL colours: RAL 1012, RAL 3005, RAL 5008, RAL 5020, RAL 6007, RAL 6020, RAL 7015, RAL 7033, RAL 7044, RAL 7045, RAL 8014, RAL 9011.

 - * Setup costs for the first custom colour € 225,00
 - Setup costs for every next custom colour € 75,00
- De Vorm offers a variety of tabletop options:
 - 28 mm MDF core + HPL, veneer, Fenix or Desktop top layer
 - 27 mm Plywood core + HPL, veneer, Fenix or Desktop top layer
 - Diverse edge finishes

Please, contact De Vorm for more information about available options.
- Tabletop can be equipped with cable cubbies. Find our standard cable cubby options on page 42.

Lite Modular Table System

Lite	Length	Width	Lite 74	Lite 95	Lite 110
Prices as mentioned on the right are indications based on the smallest length and depth, a 28 mm MDF core with an HPL Duropal U11026 finish, straight edges, a matching edgeband and rounded corners with 60 mm radius.	150 – 179	90 – 129	€ 1.569,00	€ 1.744,00	€ 1.783,00
	180 – 209	90 – 129	€ 1.764,00	€ 1.813,00	€ 1.853,00
	210 – 239	90 – 129	€ 1.871,00	€ 1.921,00	€ 1.949,00
	240 – 269	90 – 129	€ 1.955,00	€ 2.005,00	€ 2.045,00
	270 – 297	90 – 129	€ 2.030,00	€ 2.078,00	€ 2.124,00

Prices depend on length, width, height, finish of the table top and the ordered quantity.

Please, contact De Vorm for the exact quotation.



Leg options

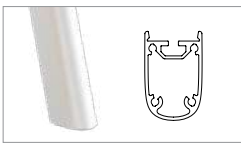

Anodised legs



Steel legs

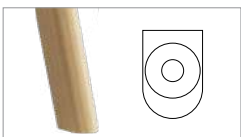

Solid oak legs

Specifications

Standard frame & legs	Anodised aluminium (VOM1 Natural)
Height	74 / 95 / 110 cm

Bespoke options

- De Vorm offers the possibility to customise the legs of the Lite Table:
 - Solid oak legs for Lite 74 no surcharge
 - Powder-coated steel legs, Black (RAL 9011) no surcharge
 - Anodised or steel legs in custom RAL colour* € 40,00
 - Anodised or steel legs in Fine texture* € 50,00

Fine texture is only available in the following RAL colours: RAL 1012, RAL 3005, RAL 5008, RAL 5020, RAL 6007, RAL 6020, RAL 7015, RAL 7033, RAL 7044, RAL 7045, RAL 8014, RAL 9011.

 - * Setup costs for the first custom colour € 225,00
 - Setup costs for every next custom colour € 75,00
- De Vorm offers a variety of tabletop options:
 - 28 mm MDF core + HPL, veneer, Fenix or Desktop top layer
 - 27 mm Plywood core + HPL, veneer, Fenix or Desktop top layer
 - Diverse edge finishes

Please, contact De Vorm for more information about available options.
- Tabletop can be equipped with cable cubbies. Find our standard cable cubby options on page 42.

Lite Round Modular Table System

Lite Round	Ø Table top	Lite Round 74	Lite Round 95	Lite Round 110
Prices as mentioned on the right are indications based on the smallest length and depth, a 28 mm MDF core with an HPL Duropal U11026 finish, straight edges, and a matching edgeband.	120	€ 1.732,00	€ 1.757,00	€ 1.775,00
	130	€ 1.892,00	€ 1.917,00	€ 1.935,00
	140	€ 1.927,00	€ 1.951,00	€ 1.969,00
	150	€ 1.946,00	€ 1.971,00	€ 1.989,00
	159	€ 1.966,00	€ 1.990,00	€ 2.009,00

Prices depend on the diameter, finish of the table top and the ordered quantity.

Please, contact De Vorm for the exact quotation.



Leg options

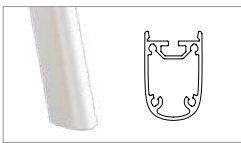

Anodised legs



Steel legs

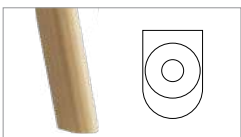

Solid oak legs

Specifications

Standard frame & legs	Anodised aluminium (VOM1 Natural)
Height	74 / 95 / 110 cm

Bespoke options





- De Vorm offers the possibility to customise the legs of the Lite Round Table:
 - Solid oak legs for Lite Round 74 no surcharge
 - Powder-coated steel legs, Black (RAL 9011) no surcharge
 - Anodised or steel legs in custom RAL colour* € 40,00
 - Anodised or steel legs in Fine texture* € 50,00

Fine texture is only available in the following RAL colours: RAL 1012, RAL 3005, RAL 5008, RAL 5020, RAL 6007, RAL 6020, RAL 7015, RAL 7033, RAL 7044, RAL 7045, RAL 8014, RAL 9011.

 - * Setup costs for the first custom colour € 225,00
 - Setup costs for every next custom colour € 75,00
- De Vorm offers a variety of tabletop options:
 - 28 mm MDF core + HPL, veneer, Fenix or Desktop top layer
 - 27 mm Plywood core + HPL, veneer, Fenix or Desktop top layer
 - Diverse edge finishes

Please, contact De Vorm for more information about available options.
- Tabletop can be equipped with cable cubbies. Find our standard cable cubby options on page 42.



Cable cubbies Standard options

		Colours	Price
Bachmann Coni		Grey metallic White Black	€ 193,00 € 199,00 € 199,00
3x 230V RA			
Bachmann Coni USB		Grey metallic White Black	€ 242,00 € 249,00 € 249,00
2x 230V RA + 2x USB-charger			
Bachmann Pix		White + Black	€ 32,00
1x 230V RA			
Bachmann Power Frame 4v		Grey metallic White Black	€ 158,00 € 166,00 € 158,00
3x 230V RA + 2x USB-charger			
Bachmann Power Frame Cover 4v		Grey metallic White Black	€ 235,00 € 287,00 € 261,00
3x 230V RA + 2x USB-charger			

- All cable cubbies are delivered with 0,2m Wieland GST18i3 connector.
- If you would like to equip a table with a custom cable cubby unit, the tabletop can be produced with one or more cut-outs.

Surcharge per cut-out € 25,00

Column Series

	Frame Black	Frame Custom colour ¹	Frame Fine texture ²
Column Table Round 60 	€ 529,00	€ 564,00	€ 571,00
Column Table Round 90 	€ 603,00	€ 638,00	€ 645,00
Column Table Round 120 	€ 868,00	€ 903,00	€ 910,00

Setup costs custom colour treatment (frame)
 – Setup costs for the first colour are € 225,00
 – Setup costs for every next colour are € 75,00

Measurements Column Table Round 60

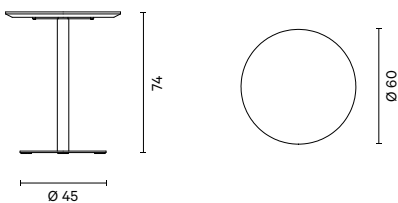

Measurements Column Table Round 90

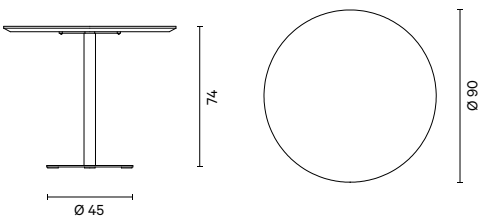

Measurements Column Table Round 120

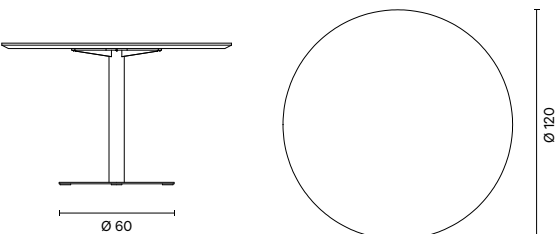

Specifications

Designed by	De Vorm
Standard tabletop	28 mm MDF core + HPL U12290 SD top layer, edges tapered and clear lacquered
Frame	Powder-coated steel
Standard frame colour	Black (RAL 9011) with 70% gloss degree

Bespoke options

¹Specified costs are based on custom RAL colours as shown at devorm.nl in gloss degree 70%. Please, contact De Vorm for availability of the preferred colour. If the RAL colour is not in stock, there may be a price consequence.

²Specified costs are based on and only available in the following RAL fine texture colours: RAL 1012, RAL 3005, RAL 5008, RAL 5020, RAL 6007, RAL 6020, RAL 7015, RAL 7033, RAL 7044, RAL 7045, RAL 8014, RAL 9011.

The tabletop is also available in other HPL, Forbo Desktop, Fenix, or veneer finishes. Contact De Vorm for more information about available options.

Additional information

The MDF core can be CARB 2 certified upon request.

MG Series

	Frame Black	Frame Custom colour ¹	Frame Fine texture ²
MG 1 Side Table	€ 322,00	€ 347,00	€ 354,00
 			

MG 2 Side Table	€ 331,00	€ 356,00	€ 363,00
 			

Setup costs custom colour treatment (frame)
 – Setup costs for the first colour are € 225,00
 – Setup costs for every next colour are € 75,00

Measurements MG 1

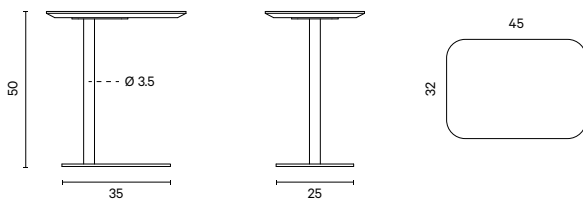

Measurements MG 2

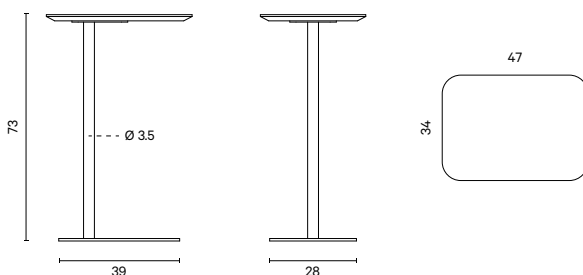

Specifications

Designed by	De Vorm
Standard tabletops	A. 19 mm MDF core + Oak veneer top layer, edges tapered and clear lacquered. B. 19 mm Black MDF core + Fenix ^{NTM} 0720 top layer, edges tapered and clear lacquered.
Frame	Powder-coated steel
Standard frame colour	Black (RAL 9011) with 70% gloss degree

Bespoke options

¹Specified costs are based on custom RAL colours as shown at devorm.nl in gloss degree 70%. Please, contact De Vorm for availability of the preferred colour. If the RAL colour is not in stock, there may be a price consequence.



²Specified costs are based on and only available in the following RAL fine texture colours: RAL 1012, RAL 3005, RAL 5008, RAL 5020, RAL 6007, RAL 6020, RAL 7015, RAL 7033, RAL 7044, RAL 7045, RAL 8014, RAL 9011.



The tabletop is also available in other HPL, Forbo, Fenix or veneer finishes. Please, contact De Vorm for more information about available options.

Additional information

The MDF core of MG 1 and MG 2 is CARB2 certified.

MG Series

	Option	Frame Black	Frame Custom colour ¹	Frame Fine texture ²	
MG 3 Table					
	 A	 B	€ 421,00	€ 446,00	€ 453,00

MG 4 Table					
	 A	 B	€ 1.198,00	€ 1.248,00	€ 1.262,00

Setup costs custom colour treatment (frame)
 – Setup costs for the first colour are € 225,00
 – Setup costs for every next colour are € 75,00

Measurements MG 3

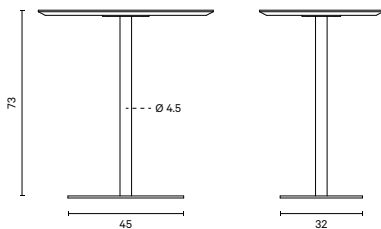

Measurements MG 4

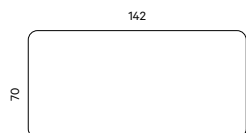
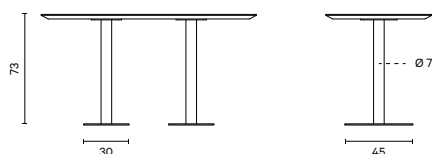

Specifications

Designed by	De Vorm
Standard tabletops	A. MDF core + Oak veneer top layer, edges tapered and clear lacquered B. Black MDF core + Fenix ^{NTM} 0720 top layer, edges tapered and clear lacquered
Frame	Powder-coated steel
Standard frame colour	Black (RAL 9011) with 70% gloss degree

Bespoke options

¹Specified costs are based on custom RAL colours as shown at devorm.nl in gloss degree 70%. Please, contact De Vorm for availability of the preferred colour. If the RAL colour is not in stock, there may be a price consequence.

²Specified costs are based on and only available in the following RAL fine texture colours: RAL 1012, RAL 3005, RAL 5008, RAL 5020, RAL 6007, RAL 6020, RAL 7015, RAL 7033, RAL 7044, RAL 7045, RAL 8014, RAL 9011.

The tabletop is also available in other HPL, Forbo, Fenix or veneer finishes. Please, contact De Vorm for more information about available options.

Additional information

The MDF core of MG 3 is CARB2 certified.
 The MDF core of MG 4 can be CARB2 certified upon request.

Tabletop thickness for MG 3 is 19 mm.
 Tabletop thickness for MG 4 is 28 mm.

Musette Series

	Qty	Table Custom colour ¹	Table Fine texture ²
Musette Coffee Table	1	€ 818,00	€ 838,00



Musette Side Table	1	€ 752,00	€ 772,00
--------------------	---	----------	----------



Measurements Musette Coffee Table

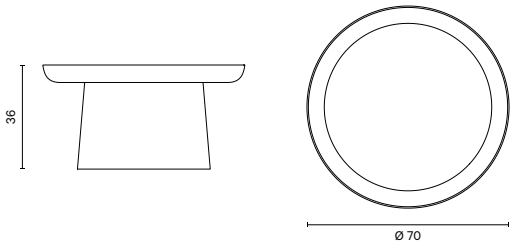

Measurements Musette Side Table

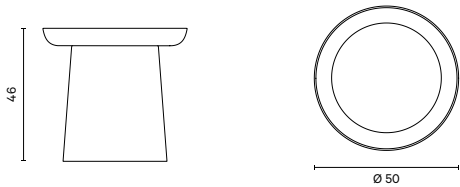

Specifications

Designed by Ionna Vautrin
 Tray & base Powder-coated aluminium

Bespoke options

¹Musette Series can be wet-coated in any custom RAL colour as shown at devorm.nl in gloss degree 70%. Please, contact De Vorm for availability of the preferred colour. If the RAL colour is not in stock, there may be a price consequence.

² Specified costs are based on and only available in the following RAL fine texture colours: RAL 1012, RAL 3005, RAL 5008, RAL 5020, RAL 6007, RAL 6020, RAL 7015, RAL 7033, RAL 7044, RAL 7045, RAL 8014, RAL 9011.

Hale Table

	Frame Black	Frame Custom colour ¹	Frame Fine texture ²
Hale Table White	€ 950,00	€ 985,00	€ 992,00

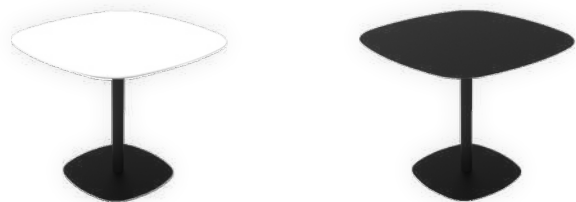

Setup costs custom colour treatment (frame)
 – Setup costs for the first colour are € 225,00
 – Setup costs for every next colour are € 75,00

Measurements

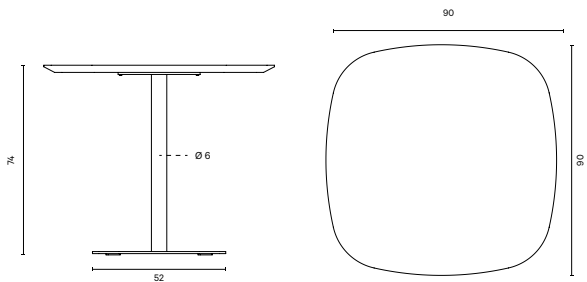

Specifications

Designed by	De Vorm
Standard tabletop	White: 25 mm MDF core + Fenix ^{NTM} 0029 Bianco Malé top layer, edges tapered and white lacquered. Finished with a clear matt lacquer Black: 25 mm Black MDF core + Fenix ^{NTM} 0720 Nero Ingo top layer, edges tapered and clear matt lacquered
Frame	Powder-coated steel
Standard frame colour	Black (RAL 9011) with 70% gloss degree

Bespoke options

¹Specified costs are based on custom RAL colours as shown at devorm.nl in gloss degree 70%. Please, contact De Vorm for availability of the preferred colour. If the RAL colour is not in stock, there may be a price consequence.

²Specified costs are based on and only available in the following RAL fine texture colours: RAL 1012, RAL 3005, RAL 5008, RAL 5020, RAL 6007, RAL 6020, RAL 7015, RAL 7033, RAL 7044, RAL 7045, RAL 8014, RAL 9011.

Additional information

The MDF core can be CARB2 certified upon request.

Acoustics

Mute Series

Mute Fit Acoustic Panel



Panel	Qty	Ex. VAT
Dark Grey, Light Grey	1	€ 355,00
	2	€ 347,00
	5	€ 339,00
	10	€ 331,00
Colour blends	1	€ 405,00
	2	€ 397,00
	5	€ 388,00
	10	€ 380,00

Quantity discount applies when ordering panels of the same colour

Measurements

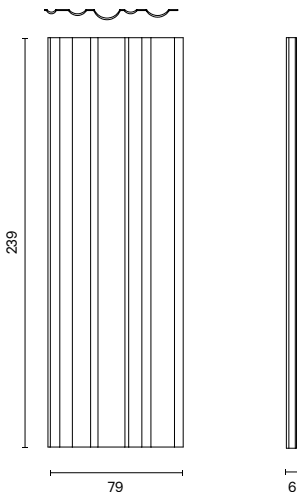

Specifications

Designed by De Vorm
 Material PET Felt
 PET Felt blends Marine, Turquoise, Olive, Dark Green, Green, Yellow, Pink, Dark Grey, Light Grey, Brown, Beige

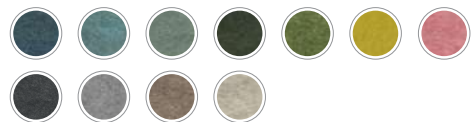

Additional information

- PET Felt is made of recycled material. Slight colour deviations may appear between different products.
- The panels can be treated with a fire retardant product. See page 71 for the surcharges.

Mute Series

Mute Fraction Acoustic Panel



Panel	Qty	Ex. VAT
Dark Grey, Light Grey	1	€ 355,00
	2	€ 347,00
	5	€ 339,00
	10	€ 331,00
Colour blends	1	€ 405,00
	2	€ 397,00
	5	€ 388,00
	10	€ 380,00

Quantity discount applies when ordering panels of the same colour

Measurements

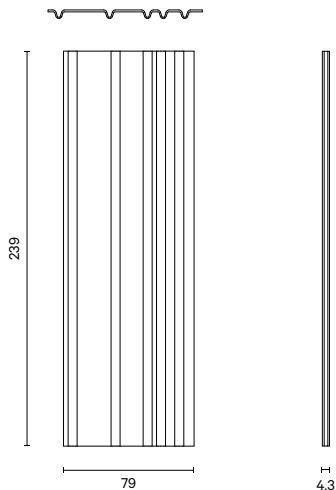

Specifications

Designed by De Vorm
 Material PET Felt
 PET Felt blends Marine, Turquoise, Olive, Dark Green, Green, Yellow, Pink, Dark Grey, Light Grey, Brown, Beige

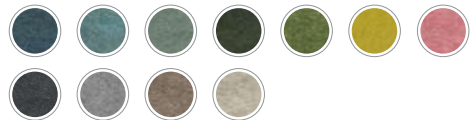

Additional information

- PET Felt is made of recycled material. Slight colour deviations may appear between different products.
- The panels can be treated with a fire retardant product. See page 71 for the surcharges.

Mute Series

Mute Flat Acoustic Panel



Panel	Qty	Ex. VAT
Dark Grey, Light Grey	1	€ 355,00
	2	€ 347,00
	5	€ 339,00
	10	€ 331,00
Colour blends	1	€ 405,00
	2	€ 397,00
	5	€ 388,00
	10	€ 380,00

Quantity discount applies when ordering panels of the same colour

Measurements

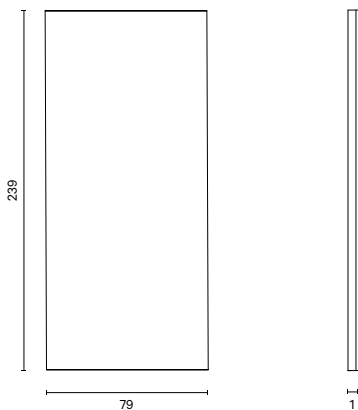

Specifications

Designed by De Vorm
 Material PET Felt
 PET Felt blends Marine, Turquoise, Olive, Dark Green, Green, Yellow, Pink, Dark Grey, Light Grey, Brown, Beige

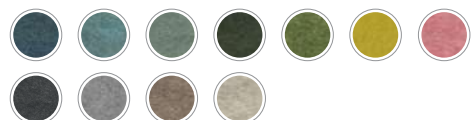

Additional information

- PET Felt is made of recycled material. Slight colour deviations may appear between different products.
- The panels can be treated with a fire retardant product. See page 71 for the surcharges.

Mute Series

Mute Flow Acoustic Panel



Panel	Qty	Ex. VAT
Dark Grey, Light Grey	1	€ 355,00
	2	€ 347,00
	5	€ 339,00
	10	€ 331,00
Colour blends	1	€ 405,00
	2	€ 397,00
	5	€ 388,00
	10	€ 380,00

Quantity discount applies when ordering panels of the same colour

Measurements

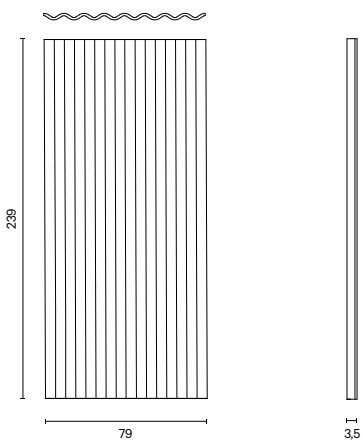

Specifications

Designed by De Vorm
 Material PET Felt
 PET Felt blends Marine, Turquoise, Olive, Dark Green, Green, Yellow, Pink, Dark Grey, Light Grey, Brown, Beige

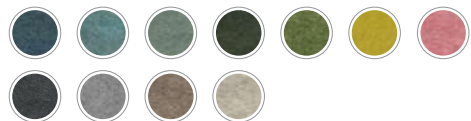

Additional information

- PET Felt is made of recycled material. Slight colour deviations may appear between different products.
- The panels can be treated with a fire retardant product. See page 71 for the surcharges.

Mute Series

Mute Flow Floating

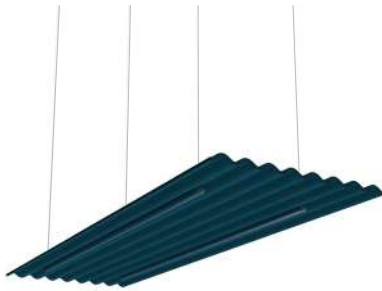

Panel		Tubes Black	Tubes Custom colour ¹	Tubes Fine texture ²
Dark Grey, Light Grey	1	€ 562,00	€ 587,00	€ 619,00
Colour blends	1	€ 636,00	€ 661,00	€ 693,00

Setup costs custom colour treatment (tubes)

- Setup costs for the first colour are € 225,00
- Setup costs for every next colour are € 75,00

Measurements

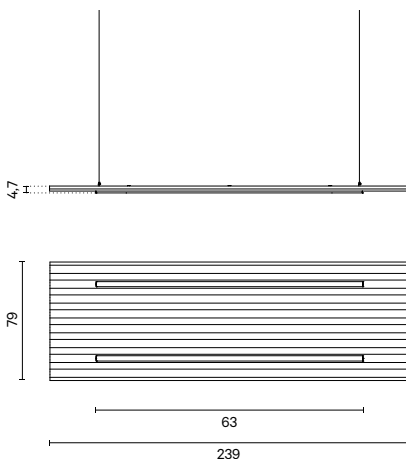

Specifications

Designed by	De Vorm
Tubes	Powder-coated steel
Standard tube colour	Black (RAL 9011) with 70% gloss degree
Panel	PET Felt
PET Felt blends	Marine, Turquoise, Olive, Dark Green, Green, Yellow, Pink, Dark Grey, Light Grey, Brown, Beige

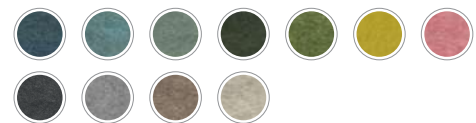

Bespoke options

¹Specified costs are based on custom RAL colours as shown at devorm.nl in gloss degree 70%. Please, contact De Vorm for availability of the preferred colour. If the RAL colour is not in stock, there may be a price consequence.

²Specified costs are based on and only available in the following RAL fine texture colours: RAL 1012, RAL 3005, RAL 5008, RAL 5020, RAL 6007, RAL 6020, RAL 7015, RAL 7033, RAL 7044, RAL 7045, RAL 8014, RAL 9011. *These colours match perfectly with our PET Felt blends. See page 73 for ton-sur-ton colour combinations.*

Additional information

- PET Felt is made of recycled material. Slight colour deviations may appear between different products.
- The panels can be treated with a fire retardant product. See page 71 for the surcharges.

Mute Series

Mute Flow Floating Light



Panel		Tubes Black	Tubes Custom colour ¹	Tubes Fine texture ²
Dark Grey, Light Grey	1	€ 736,00	€ 761,00	€ 793,00
Colour blends	1	€ 826,00	€ 851,00	€ 883,00

Setup costs custom colour treatment (tubes)
 – Setup costs for the first colour are € 225,00
 – Setup costs for every next colour are € 75,00

Measurements

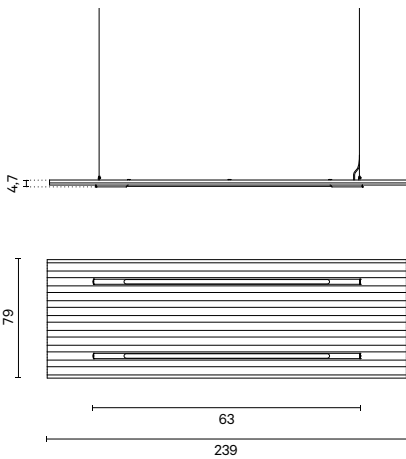

Specifications

Designed by De Vorm
 Tubes Powder-coated steel
 Standard tube colour Black (RAL 9011) with 70% gloss degree
 Lights 2 x Philips CorePro LEDtube 1500mm 20W840 (non-dimmable)
 Panel PET Felt
 PET Felt blends Marine, Turquoise, Olive, Dark Green, Green, Yellow, Pink, Dark Grey, Light Grey, Brown, Beige

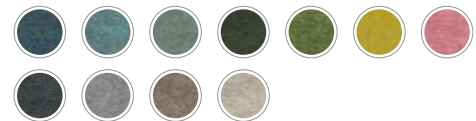

Bespoke options

¹Specified costs are based on custom RAL colours as shown at devorm.nl in gloss degree 70%. Please, contact De Vorm for availability of the preferred colour. If the RAL colour is not in stock, there may be a price consequence.

²Specified costs are based on and only available in the following RAL fine texture colours: RAL 1012, RAL 3005, RAL 5008, RAL 5020, RAL 6007, RAL 6020, RAL 7015, RAL 7033, RAL 7044, RAL 7045, RAL 8014, RAL 9011. *These colours match perfectly with our PET Felt blends. See page 73 for ton-sur-ton colour combinations.*

Additional information

- PET Felt is made of recycled material. Slight colour deviations may appear between different products.
- The panels can be treated with a fire retardant product. See page 71 for the surcharges.

Mute Series

Mute Flow Room Divider



Panel		Stand Black	Stand Custom colour ¹	Stand Fine texture ²
Dark Grey, Light Grey	1	€ 736,00	€ 786,00	€ 850,00
Colour blends	1	€ 826,00	€ 876,00	€ 940,00

Setup costs custom colour treatment (tubes)
 – Setup costs for the first colour are € 225,00
 – Setup costs for every next colour are € 75,00

Measurements

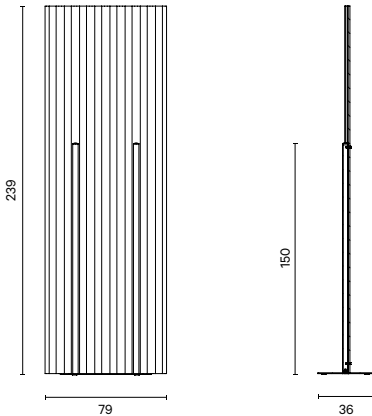

Specifications

Designed by De Vorm
 Stand Powder-coated steel
 Standard stand colour Black (RAL 9011) with 70% gloss degree
 Panel PET Felt
 PET Felt blends Marine, Turquoise, Olive, Dark Green, Green, Yellow, Pink, Dark Grey, Light Grey, Brown, Beige

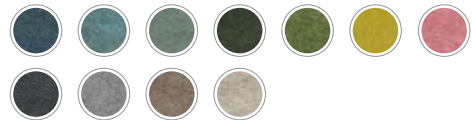

Bespoke options

¹Specified costs are based on custom RAL colours as shown at devorm.nl in gloss degree 70%. Please, contact De Vorm for availability of the preferred colour. If the RAL colour is not in stock, there may be a price consequence.

²Specified costs are based on and only available in the following RAL fine texture colours: RAL 1012, RAL 3005, RAL 5008, RAL 5020, RAL 6007, RAL 6020, RAL 7015, RAL 7033, RAL 7044, RAL 7045, RAL 8014, RAL 9011. *These colours match perfectly with our PET Felt blends. See page 73 for ton-sur-ton colour combinations.*

Additional information

- PET Felt is made of recycled material. Slight colour deviations may appear between different products.
- The panels can be treated with a fire retardant product. See page 71 for the surcharges.

AK Series

AK 1 Workplace Divider



Colour	Qty	Ex. VAT
Dark Grey, Light Grey	1	€ 322,00
Colour blends	1	€ 380,00

Measurements

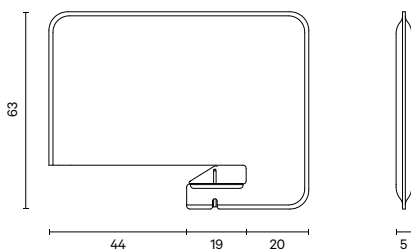

Specifications

Designed by De Vorm
 Material PET Felt
 PET Felt blends Marine, Turquoise, Olive, Dark Green, Green, Yellow, Pink, Dark Grey, Light Grey, Brown, Beige

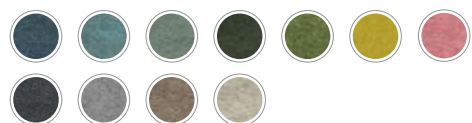

Additional information

- PET Felt is made of recycled material. Slight colour deviations may appear between different products.
- Suitable for tabletops from 20 mm up to 40 mm.

AK Series

AK 2 Workplace Divider Lamps

AK 2 Workplace Divider Lamp Hanging



Shell	Qty	Fixture / Feet Black	Fixture / Feet Custom colour ¹	Fixture / Feet Fine texture ²
Dark Grey, Light Grey	1	€ 760,00	€ 770,00	€ 777,00
Colour blends	1	€ 810,00	€ 820,00	€ 827,00

AK 2 Workplace Divider Lamp Standing



Dark Grey, Light Grey	1	€ 785,00	€ 805,00	€ 818,00
Colour blends	1	€ 868,00	€ 888,00	€ 901,00

Setup costs custom colour treatment (fixture / feet)

– Setup costs for every colour are € 75,00

Measurements AK 2 Hanging

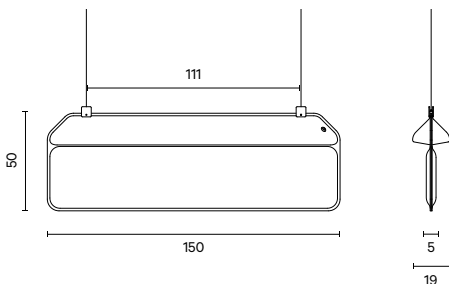

Measurements AK 2 Standing

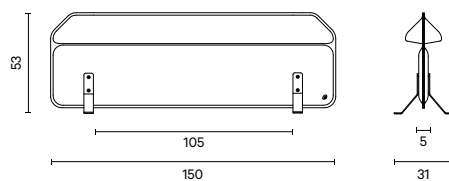

Specifications

Designed by	De Vorm & Ivan Kasner
Fixture / feet	Powder-coated steel
Standard fixture / feet colour	Black (RAL 9011) with 70% gloss degree
Lights	2x Philips CorePro LEDtube 1200mm 14.5W840 (non-dimmable)
Shell	PET Felt
PET Felt blends	Marine, Turquoise, Olive, Dark Green, Green, Yellow, Pink, Dark Grey, Light Grey, Brown, Beige



Bespoke options

¹The colour of the fixture and feet can be customised. Specified costs are based on RAL colours as shown at devorm.nl in gloss degree 70%. Please, contact De Vorm for availability of the preferred colour. If the RAL colour is not in stock, there may be a price consequence.

²Specified costs are based on and only available in the following RAL fine texture colours: RAL 1012, RAL 3005, RAL 5008, RAL 5020, RAL 6007, RAL 6020, RAL 7015, RAL 7033, RAL 7044, RAL 7045, RAL 8014, RAL 9011. *These colours match perfectly with our PET Felt blends. See page 73 for ton-sur-ton colour combinations.*

The length of steel cables and cord can be customised upon request. Please, contact De Vorm for more information.

Additional information

- PET Felt is made of recycled material. Slight colour deviations may appear between different products.
- AK 2 Hanging comes with 3-meter steel cables and a transparent cord.
- AK 2 Standing comes with a 3-meter transparent cord and plug.

AK Series

AK 3 Workplace Dividers

AK 3 Workplace Divider Hanging (horizontal)



Panel	Qty	Fixture / Feet Black	Fixture / Feet Custom colour ¹	Fixture / Feet Fine texture ²
Dark Grey, Light Grey	1	€ 595,00	€ 605,00	€ 612,00
Colour blends	1	€ 678,00	€ 688,00	€ 695,00

AK 3 Workplace Divider Standing (horizontal)



Dark Grey, Light Grey	1	€ 612,00	€ 632,00	€ 645,00
Colour blends	1	€ 694,00	€ 714,00	€ 727,00

Setup costs custom colour treatment

– Setup costs for every colour are € 75,00

Measurements AK 3 Workplace Divider Hanging

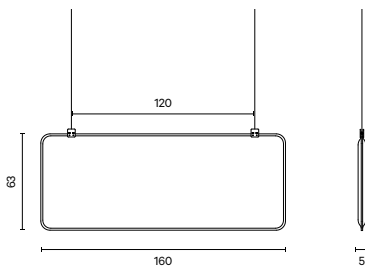

Specifications

Designed by	De Vorm
Fixture / feet	Powder-coated steel, Black (RAL 9011)
Standard fixture / feet colour	Black (RAL 9011) with 70% gloss degree
Panel	PET Felt
PET Felt blends	Marine, Turquoise, Olive, Dark Green, Green, Yellow, Pink, Dark Grey, Light Grey, Brown, Beige

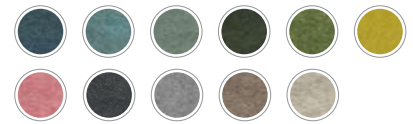

Measurements AK 3 Workplace Divider Standing

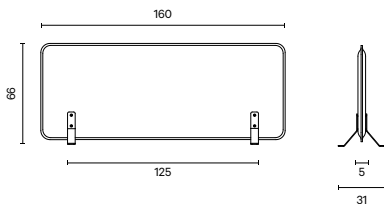

Bespoke options

¹Specified costs are based on custom RAL colours as shown at devorm.nl in gloss degree 70%. Please, contact De Vorm for availability of the preferred colour. If the RAL colour is not in stock, there may be a price consequence.

²Specified costs are based on and only available in the following RAL fine texture colours: RAL 1012, RAL 3005, RAL 5008, RAL 5020, RAL 6007, RAL 6020, RAL 7015, RAL 7033, RAL 7044, RAL 7045, RAL 8014, RAL 9011. *These colours match perfectly with our PET Felt blends. See page 73 for ton-sur-ton colour combinations.*

Additional information

PET Felt is made of recycled material. Slight colour deviations may appear between different products.

AK Series

AK 4 Workplace Dividers

AK 4 Workplace Divider
Hanging (horizontal)



Panel	Qty	Fixture / Feet Black	Fixture / Feet Custom colour ¹	Fixture / Feet Fine texture ²
Dark Grey, Light Grey	1	€ 628,00	€ 638,00	€ 645,00
Colour blends	1	€ 694,00	€ 704,00	€ 711,00

AK 4 Workplace Divider
Standing (horizontal)



Dark Grey, Light Grey	1	€ 645,00	€ 665,00	€ 678,00
Colour blends	1	€ 711,00	€ 731,00	€ 744,00

Setup costs custom colour treatment

– Setup costs for every colour are € 75,00

Measurements AK 4 Workplace Divider Hanging

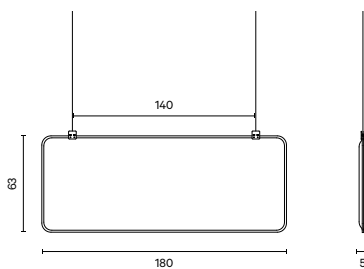

Specifications

Designed by	De Vorm
Fixture / feet	Powder-coated steel, Black (RAL 9011)
Standard fixture / feet colour	Black (RAL 9011) with 70% gloss degree
Panel	PET Felt
PET Felt blends	Marine, Turquoise, Olive, Dark Green, Green, Yellow, Pink, Dark Grey, Light Grey, Brown, Beige

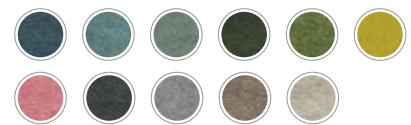

Measurements AK 4 Workplace Divider Standing

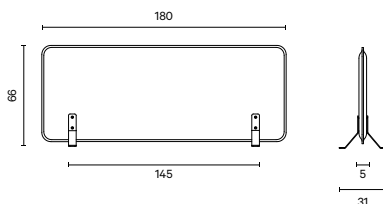

Bespoke options

¹Specified costs are based on custom RAL colours as shown at devorm.nl in gloss degree 70%. Please, contact De Vorm for availability of the preferred colour. If the RAL colour is not in stock, there may be a price consequence.

²Specified costs are based on and only available in the following RAL fine texture colours: RAL 1012, RAL 3005, RAL 5008, RAL 5020, RAL 6007, RAL 6020, RAL 7015, RAL 7033, RAL 7044, RAL 7045, RAL 8014, RAL 9011. *These colours match perfectly with our PET Felt blends. See page 73 for ton-sur-ton colour combinations.*

Additional information

PET Felt is made of recycled material. Slight colour deviations may appear between different products.

AK Series

AK 3 Room Dividers		Panel	Qty	Fixture / Feet Black	Fixture / Feet Custom colour ¹	Fixture / Feet Fine texture ²
AK 3 Room Divider Hanging (vertical)		Dark Grey, Light Grey	1	€ 595,00	€ 605,00	€ 612,00
		Colour blends	1	€ 678,00	€ 688,00	€ 695,00

AK 3 Room Divider Standing (vertical)		Dark Grey, Light Grey	1	€ 612,00	€ 632,00	€ 645,00
		Colour blends	1	€ 694,00	€ 714,00	€ 727,00

Setup costs custom colour treatment

– Setup costs for every colour are € 75,00

Measurements AK 3 Room Divider Hanging

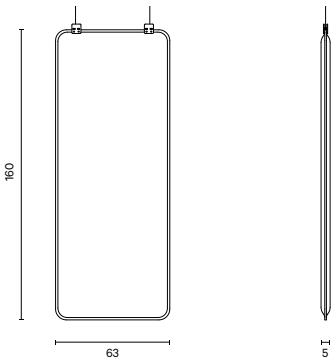

Measurements AK 3 Room Divider Standing

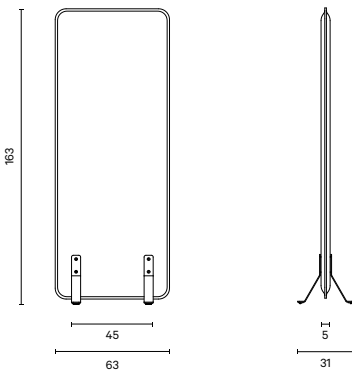

Specifications

Designed by	De Vorm
Fixture / feet	Powder-coated steel, Black (RAL 9011)
Standard fixture / feet colour	Black (RAL 9011) with 70% gloss degree
Panel	PET Felt
PET Felt blends	Marine, Turquoise, Olive, Dark Green, Green, Yellow, Pink, Dark Grey, Light Grey, Brown, Beige

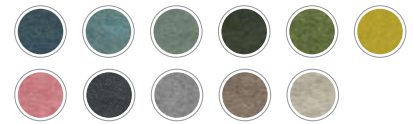

Bespoke options

¹Specified costs are based on custom RAL colours as shown at devorm.nl in gloss degree 70%. Please, contact De Vorm for availability of the preferred colour. If the RAL colour is not in stock, there may be a price consequence.

²Specified costs are based on and only available in the following RAL fine texture colours: RAL 1012, RAL 3005, RAL 5008, RAL 5020, RAL 6007, RAL 6020, RAL 7015, RAL 7033, RAL 7044, RAL 7045, RAL 8014, RAL 9011. *These colours match perfectly with our PET Felt blends. See page 73 for ton-sur-ton colour combinations.*

Additional information

PET Felt is made of recycled material. Slight colour deviations may appear between different products.

AK Series

AK 4 Room Dividers

AK 4 Room Divider
Hanging (vertical)



Panel	Qty	Fixture / Feet Black	Fixture / Feet Custom colour ¹	Fixture / Feet Fine texture ²
Dark Grey, Light Grey	1	€ 628,00	€ 638,00	€ 645,00
Colour blends	1	€ 694,00	€ 704,00	€ 711,00

AK 4 Room Divider
Standing (vertical)



Dark Grey, Light Grey	1	€ 645,00	€ 665,00	€ 678,00
Colour blends	1	€ 711,00	€ 731,00	€ 744,00

Setup costs custom colour treatment

– Setup costs for every colour are € 75,00

Measurements AK 4 Room Divider Hanging

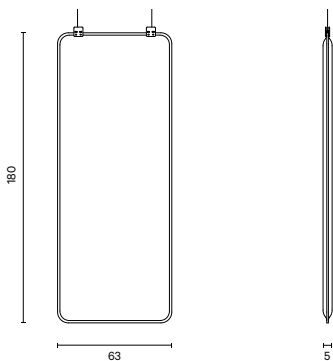

Measurements AK 4 Room Divider Standing

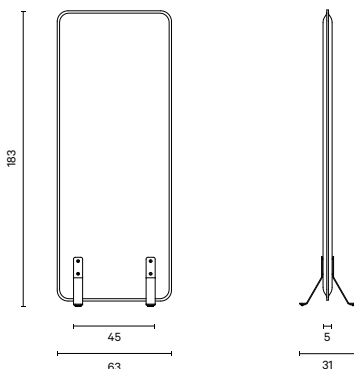

Specifications

Designed by	De Vorm
Fixture / feet	Powder-coated steel, Black (RAL 9011)
Standard fixture / feet colour	Black (RAL 9011) with 70% gloss degree
Panel	PET Felt
PET Felt blends	Marine, Turquoise, Olive, Dark Green, Green, Yellow, Pink, Dark Grey, Light Grey, Brown, Beige



Bespoke options

¹Specified costs are based on custom RAL colours as shown at devorm.nl in gloss degree 70%. Please, contact De Vorm for availability of the preferred colour. If the RAL colour is not in stock, there may be a price consequence.

²Specified costs are based on and only available in the following RAL fine texture colours: RAL 1012, RAL 3005, RAL 5008, RAL 5020, RAL 6007, RAL 6020, RAL 7015, RAL 7033, RAL 7044, RAL 7045, RAL 8014, RAL 9011. *These colours match perfectly with our PET Felt blends. See page 73 for ton-sur-ton colour combinations.*

Additional information

PET Felt is made of recycled material. Slight colour deviations may appear between different products.

AK Series

		Qty	Hinge Black	Hinge Custom colour ¹	Hinge Fine texture ²
Hinge AK 3+4	Panels not included	1 set	€ 124,00	€ 144,00	€ 157,00



Setup costs custom colour treatment

– Setup costs for every colour are € 75,00

Specifications

Designed by	De Vorm
Hinge	Powder-coated steel
Standard hinge colour	Black (RAL 9011) with 70% gloss degree

Bespoke options

¹Specified costs are based on custom RAL colours as shown at devorm.nl in gloss degree 70%. Please, contact De Vorm for availability of the preferred colour. If the RAL colour is not in stock, there may be a price consequence.

²Specified costs are based on and only available in the following RAL fine texture colours: RAL 1012, RAL 3005, RAL 5008, RAL 5020, RAL 6007, RAL 6020, RAL 7015, RAL 7033, RAL 7044, RAL 7045, RAL 8014, RAL 9011. *These colours match perfectly with our PET Felt blends. See page 73 for ton-sur-ton colour combinations.*

Additional information

This set consists of two hinges and is suitable for connecting two AK 3 or AK 4 Room Dividers.

PET Felt is made of recycled material. Slight colour deviations may appear between different products.

Onde Series

Onde Acoustic Panel



Panel	Qty	Ex. VAT
Dark Grey, Light Grey	1 - 10	€ 198,00
	11 - 50	€ 193,00
	> 50	€ 190,00
Colour blends	1 - 10	€ 207,00
	11 - 50	€ 203,00
	> 50	€ 198,00

Quantity discount applies when ordering panels of the same colour

Onde Floating Fixture



	Qty	Ex. VAT
Panels not included. Floating fixture is suitable for three Onde panels.	1	€ 98,00

Availability based on stock levels. Please contact sales@devorm.nl for more information.

Measurements Onde Acoustic Panel

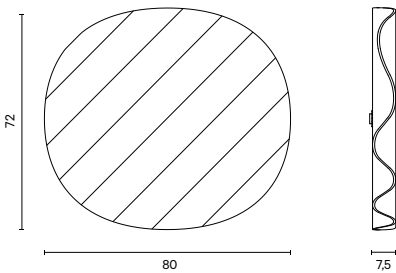

Specifications

Designed by Perrine Vigneron
 Panel PET Felt
 PET Felt blends Marine, Turquoise, Olive, Dark Green, Green, Yellow, Pink, Dark Grey, Light Grey, Brown, Beige

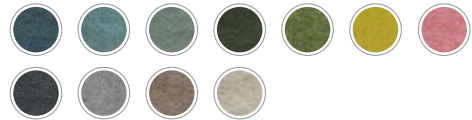

Measurements Onde Floating Fixture

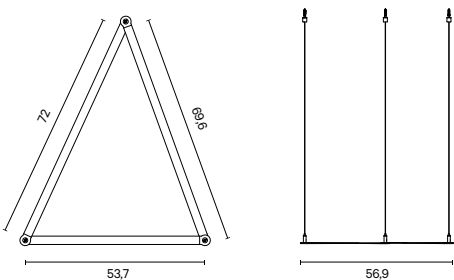

Additional information

PET Felt is made of recycled material. Slight colour deviations may appear between different products.

Pivot Series

	Colour panel	Qty	Ex. VAT
Pivot Adjustable Lamp	Dark Grey, Light Grey	1	€ 742,00
	Colour blends	1	€ 825,00



Pivot Adjustable Lamp Duo	Dark Grey, Light Grey	1	€ 1.155,00
	Colour blends	1	€ 1.238,00

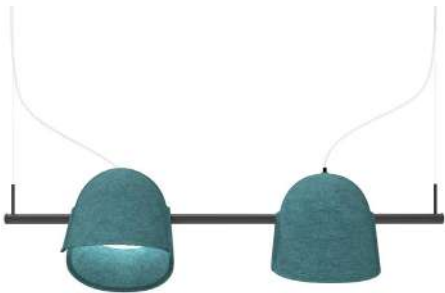

Measurements Pivot Adjustable Lamp

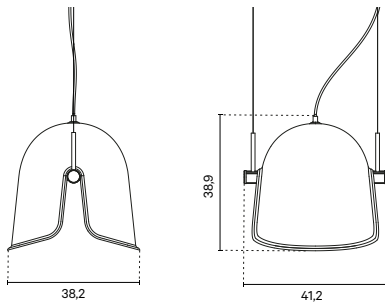

Measurements Pivot Adjustable Lamp Duo

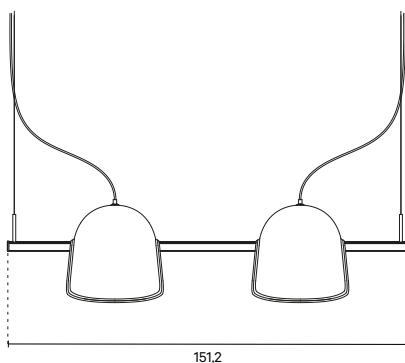

Specifications

Designed by	De Vorm
LED module	Ø 300mm, 25W
Light output	1800 Lm
Voltage	110V - 240V
Colour temperature	3000K / 4000K
Dimmable	Dali dimmable
Tube	Anodised aluminium (Black)
Shell	PET Felt
PET Felt blends	Marine, Turquoise, Olive, Dark Green, Green, Yellow, Pink, Dark Grey, Light Grey, Brown, Beige



Additional information

- PET Felt is made of recycled material. Slight colour deviations may appear between different products.
- Steel cables and cord length can be customised upon request. Please, contact De Vorm for more information.

Fost Series

Fost Acoustic Lamp



Shell	Qty	Ex. VAT
Dark Grey, Light Grey	1	€ 744,00
Colour blends	1	€ 818,00

Measurements

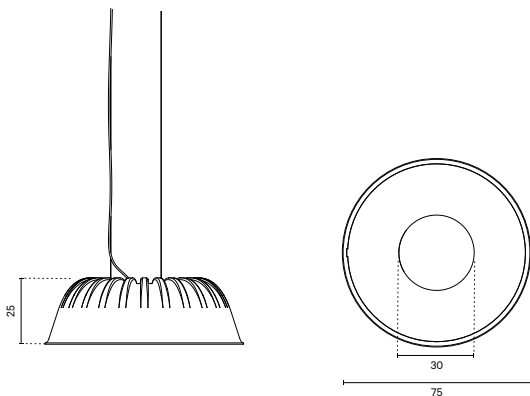

Specifications

Designed by	De Vorm
LED module	300mm, 18W
Light output	1850 Lm
Voltage	220 - 240V
Colour temperature	3000K / 4000K / 5700K
Dimmable	Yes (trailing edge)
Inner inlay	Textile (white)
Shell	PET Felt
PET Felt blends	Marine, Turquoise, Olive, Dark Green, Green, Yellow, Pink, Dark Grey, Light Grey, Brown, Beige



Additional information

- PET Felt is made of recycled material. Slight colour deviations may appear between different products.
- The length of steel cables and cord can be customised upon request. Please, contact De Vorm for more information.

Fost Series

Fost Bulb Acoustic Lamp



Colour panel	Qty	Ex. VAT
Dark Grey, Light Grey	1	€ 444,00
Colour blends	1	€ 494,00

Measurements

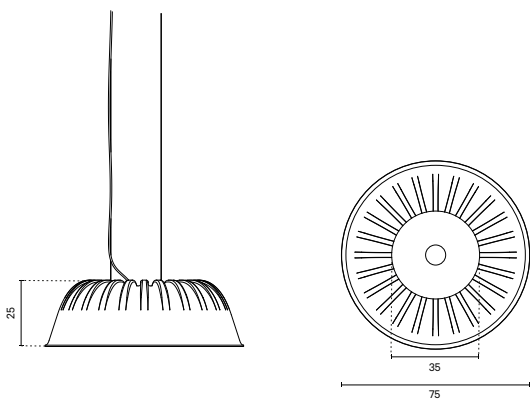

Specifications

Designed by	De Vorm
Fitting	E27
Inner plate	Steel, powder-coated (RAL 9010)
Shell	PET Felt
PET Felt blends	Marine, Turquoise, Olive, Dark Green, Green, Yellow, Pink, Dark Grey, Light Grey, Brown, Beige



Additional information

- Light bulb is not included.
- PET Felt is made of recycled material. Slight colour deviations may appear between different products.
- The length of steel cables and cord can be customised upon request. Please, contact De Vorm for more information.

LW Series

LW 2 Rubber Pendant Lamp



Qty

Ex. VAT

1 - 9

€ 132,00

10 - 24

€ 127,00

> 24

€ 121,00

Measurements

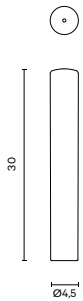

Specifications

Designed by Laurens van Wieringen
 Lampshade Vinyl
 Cord 3000mm
 Colour combinations Black lampshade + black cord
 Grey lampshade + yellow cord

LW 3 Rubber Pendant Lamp



Qty

Ex. VAT

1 - 9

€ 190,00

10 - 24

€ 187,00

> 24

€ 182,00

Measurements

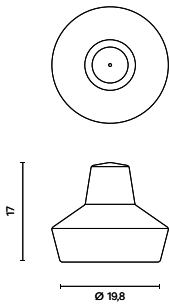

Specifications

Designed by Laurens van Wieringen
 Lampshade Vinyl
 Cord 3000mm
 Colour combinations Black lampshade + black cord
 Grey lampshade + yellow cord

LW Series

LW 4 Rubber Pendant Lamp

Qty

Ex. VAT



1 - 9

€ 207,00

10 - 24

€ 203,00

> 24

€ 198,00

Measurements

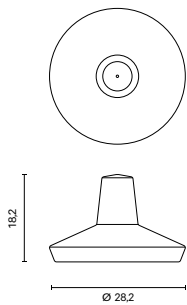

Specifications

Designed by	Laurens van Wieringen
Lampshade	Vinyl
Cord	3000mm
Colour combinations	Black lampshade + black cord Grey lampshade + yellow cord

LW 5 Rubber Pendant Lamp

Qty

Ex. VAT



1 - 9

€ 215,00

10 - 24

€ 212,00

> 24

€ 207,00

Measurements

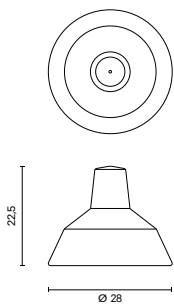

Specifications

Designed by	Laurens van Wieringen
Lampshade	Vinyl
Cord	3000mm
Colour combinations	Black lampshade + black cord Grey lampshade + yellow cord

Additional information

Mute panels fire treatment

We offer the possibility to treat the Mute panels with a fire retardant product. See the applicable surcharges below:

Quantity	Price
25 - 49	€ 48,00
50 - 99	€ 40,00
100 - 249	€ 36,00
250 - 499	€ 30,00
> 500	€ 26,00

The treated panels were tested according to EN_13501-1:2018. Contact De Vorm if you would like to receive the corresponding reports.

Note: in the course of the testing, Mute panels were mounted directly on a non-combustible background. If you use any mounting materials during the installation, make sure they also receive a fire-retardant treatment

Chairs, Armchairs & Couches

Kvadrat fabrics

We are using the following fabrics as an indication:

A Reflect, Remix 3, Revive 1

B Melange Nap, Patio, Re-wool

C Steelcut Trio 3, Tonica 2

D Fiord, Jaali

E Divina MD, Divina Melange 3, Hallingdal 65, Mosaic 2

F Coda 2, Razzle Dazzle

Ohmann leathers

We are using the following fabrics as an indication:

G 1012

H Misto

Additional information

All upholstery fabrics and leather may develop folds after some time.

The amount of folds usually depends on the stretch abilities of the fabric.

Your dealer may give you advice in the field. Minor differences in colour and structure in comparison with samples and showroom models may occur.

Ton-sur-ton colour combinations

Below you will find the recommended RAL colours to match our PET Felt blends

RAL colour	PET Felt colour
RAL 1012	Yellow
RAL 3005	Pink
RAL 5008	Marine
RAL 5020	Turquoise
RAL 6007	Dark Green
RAL 6020	Green
RAL 7015	Dark Grey
RAL 7033	Olive
RAL 7044	Beige
RAL 7045	Light Grey
RAL 8014	Brown

General Terms & Conditions

General Terms

Contractual language

The contractual language is Dutch. The English version of these General Terms and Conditions only serves the convenience of the partner. In the case of conflict between the Dutch and the English version of these terms and conditions, the Dutch version will prevail.

1 Applicability of the General Terms and Conditions

- 1.1 These General Terms and Conditions are applicable to all offers, agreements and deliveries concerning De Vorm B.V. trading as De Vorm and hereafter named "De Vorm", and all associated products. In these General Terms and Conditions, the opposite party to De Vorm shall further be referred to as "the Client".
- 1.2 Any purchase conditions of the Client shall not seclude or restrict these General Terms and Conditions.

2 Offers and agreements

- 2.1 All offers and quotations by De Vorm are without commitment.
- 2.2 Agreements between De Vorm and the Client are only achieved, when they have been confirmed explicitly in writing by De Vorm. Orders may only be cancelled upon approval by De Vorm.

3 Delivery times

Delivery times as stated by De Vorm are solely an indication of a tendency and may not be seen as definite date, if it hasn't been agreed on otherwise in an explicitly written form.

4 Force majeure and changes of circumstances

- 4.1 If, after the achievement of an agreement, the prices for primary products, wages, import procedures, taxes or other external costs (if not an effect of currency changes) rise, then De Vorm is entitled to adjust their retail prices accordingly. In such circumstances, De Vorm will inform the Client as soon as possible, which entitles the Client to terminate the agreement within 8 days.
- 4.2 If De Vorm is unable to execute an agreement as a result of force majeure, De Vorm is entitled to dissolve the agreement either in its entirety or in part or to halt its obligations until the state of force majeure has passed. The Client is then obligated to pay for the already delivered goods.

5 Variations

All data, models and images concerning colours, materials, measures and processing are sole indications. Occurring variations may not form a ground for complaints, compensations, termination of an agreement or price deductions, if these variations are considered to be of minor importance.

- 6 Deliveries
Orders are only delivered postage free, if it has been explicitly agreed on. If goods are not delivered postage free, De Vorm is entitled to charge shipping costs.

7 Risk

The risk for all products to be delivered, devolves from De Vorm upon the Client once they have left De Vorm's places of transshipment, whereby it is of no concern, what has been agreed on beforehand between De Vorm and the Client regarding transport and insurance.

- 8 Refusal of delivery by the Client
If the Client refuses a delivery, De Vorm is entitled to charge him with all resulting costs. Furthermore, De Vorm may, in this case, terminate the agreement, reserving the right to demand total compensation.

9 Payment

- 9.1 De Vorm is entitled to demand (partial) advance payment or pay on delivery at all times.
- 9.2 If goods are delivered on account, the payment must be made within 14 days, whereby the Client is not entitled to any price deductions or offsetting.
- 9.3 If a due date for payment is exceeded and no (partly) payment has been received, the Client will be legally in default and charged to pay daily interest corresponding to the state interest rate. The Client will be charged with all costs such as legal costs and extrajudicial and judicial costs, including costs for legal aid, bailiffs and debt collecting agencies, that accrued for De Vorm due to late payments. Extrajudicial costs are set for this purpose at no less than 15% of the sum due, with a minimum of € 150,- excl. VAT.

10 Grant of a delay

If the Client is in default or if De Vorm has good reason to presume that the Client does not or cannot adequately comply with his obligations and/or on time towards De Vorm, then De Vorm will be entitled to (partly) suspend the execution of all agreements or to dissolve them completely or in part without giving notice of default or judicial intervention being required and without being obliged itself to pay any compensation, whereby any obligations of the Client may be made enforceable immediately.

11 Reservation of ownership

- 11.1 All delivered products remain the property of De Vorm until the Client has adequately complied with all his obligations towards De Vorm according to the terms and conditions of the agreement.
- 11.2 The Client is only allowed to sell the products, that have remained the property of De Vorm in regards to this condition, within the scope of his company's normal exercises.
- 11.3 If the Client is in default or if De Vorm has good reason to presume that the Client does not or cannot adequately comply with his obligations towards De Vorm, then De Vorm will be entitled to reclaim delivered products from the Client or from third parties, who are engaged in business with the Client. The Client has to grant full cooperation in this case.

12 Claims

- 12.1 Within 10 days after receipt of the products - and immediately in case of external damages - the Client has to file and send a detailed and precise claim in writing to De Vorm, in which he presents his complaint.
- 12.2 Without prejudice to the generality of the foregoing, the Client is obliged to examine the delivered products before they are taken in use, adjusted or sold.

13 Returns

Returns of delivered products may only take place after confirmed in writing by De Vorm, whereby De Vorm is entitled to issue instructions regarding the manner of shipping.

14 Intellectual property rights

De Vorm has and keeps all intellectual property rights based and founded on the design.

15 Liability for damage

- 15.1 De Vorm is not liable for damage as a result of inappropriate or misapplied utilisation and much else, as long as the damage was not caused directly and solely due to wanton negligence or intent by De Vorm.
- 15.2 A damage is only qualified for compensation, if the Client has incontrovertibly stated, that the damage occurred due to a circumstance or incident for which De Vorm can be held legally liable.
- 15.3 Damage due to diminished win or lost profits is not qualified for compensation in any case.
- 15.4 Damage in association with damage or loss of a business or injury of a person is qualified for compensation up until an amount of the maximum order value that applies to the (part) delivery, with an understanding that the amount may not be higher than € 45.000,- and in any case at all times limited to a maximum of the amount that the insurance of De Vorm covers.
- 15.5 The Client prevents De Vorm from liability and compensation for damage caused by third parties, that were involved in the execution of the agreement on request by and with confirmation of the Client. The same applies to damage caused by materials, that were delivered by third parties on request by and with confirmation of the Client.
- 15.6 De Vorm is not liable for damage caused by inappropriate or misapplied utilisation of the delivered goods.

16 Dutch law

The Dutch law applies to this agreement. In case of dispute, the judge of the city, in which De Vorm is located, will be authorised, unless the dispute exceeds the relative competence of the circuit judge.

Conditions

Lead time production	<p>The lead time of production accounts for 6 - 8 weeks following the order receipt or when payment in advance is demanded, following receipt of payment. For furniture orders in non-standard sizes or non-standard finish, the production time can be longer than specified above. You are welcome to contact De Vorm for more information about lead times.</p>
Payment NL	<p>Payment must be made within 14 days following the invoice date. The invoice will be received at the moment of delivery.</p> <p><i>Exceptions:</i> First orders demand a complete advance payment. Follow-up orders with an order amount above € 5.000,00 ex. VAT and Follow-up orders that include tailor-made products regardless of the amount demand a prepayment of 30% when order is placed, 60 % before delivery and 10 % within 14 days after delivery. The delivery time will commence from the moment of receipt of prepayment.</p>
Payment foreign countries	<p>Payment must be made within 14 days following the invoice date. The invoice will be received at the moment of delivery.</p> <p><i>Exceptions:</i> First orders demand a complete advance payment. Follow-up orders with an order amount above € 1.000,00 excl. VAT and that include tailor-made products regardless of the amount demand a prepayment of 50% when order is placed and 50% before delivery. The delivery time will commence from the moment of receipt of payment.</p>
Transport	<p>All prices of De Vorm are ex works. De Vorm will give a quotation for shipping. Quoted shipping costs are based on delivery in a certain week on the ground floor behind the first door.</p>
Warranty & Maintenance	<p>For more information about our warranty conditions, consult the terms of warranty of De Vorm on www.devorm.nl. For more information about maintenance, consult our maintenance instructions on www.devorm.nl.</p>
Colours & deviation	<p>Minor differences in colour and structure in comparison with the samples and showroom models as well as minor deviations in dimensions may occur.</p>

